

### TECHNICAL SPECIFICATIONS

VOLTS		120
AMPS		12.5
WATTS		1500
HEATER	HIGH	1500 watts
	LOW	750 watts
NO HEATER		19 watts
LAMPS	QUANTITY	LED
	WATTS	
	TOTAL WATTS	19 watts
ROTOR MOTOR		1 at 5 watts
HEIGHT,WIDTH,DEPTH		26 5/8" x 75 1/4" x 10 5/8"
GLASS VIEWING OPENING		15 5/8" X 71 5/8"
GLASS SIZE		15 5/8" X 71 5/8"
SHIPPING SIZE		29 1/8" x 79 5/8" x 12 5/8"
SHIPPING WEIGHT		00.0 lbs
	UNIT	
	GLASS FRONT	Included
PLUG LOCATION		Left Side
CORD LENGTH		76"
APPROX. HEATING AREA		400 sq ft

*Amantii*

SERIES	MODEL		REV
TRU VIEW	72-TV-SLIM		1
SCALE 1"=1'-0"	DATE: 9/4/2019	SHEET 1 OF 1	

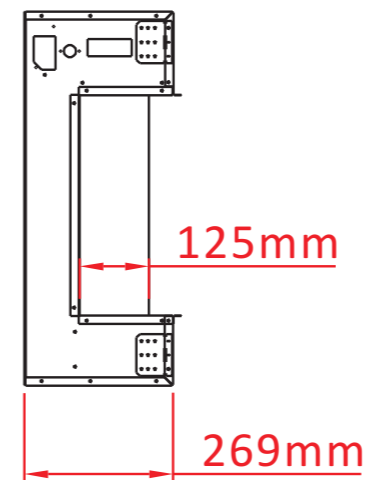
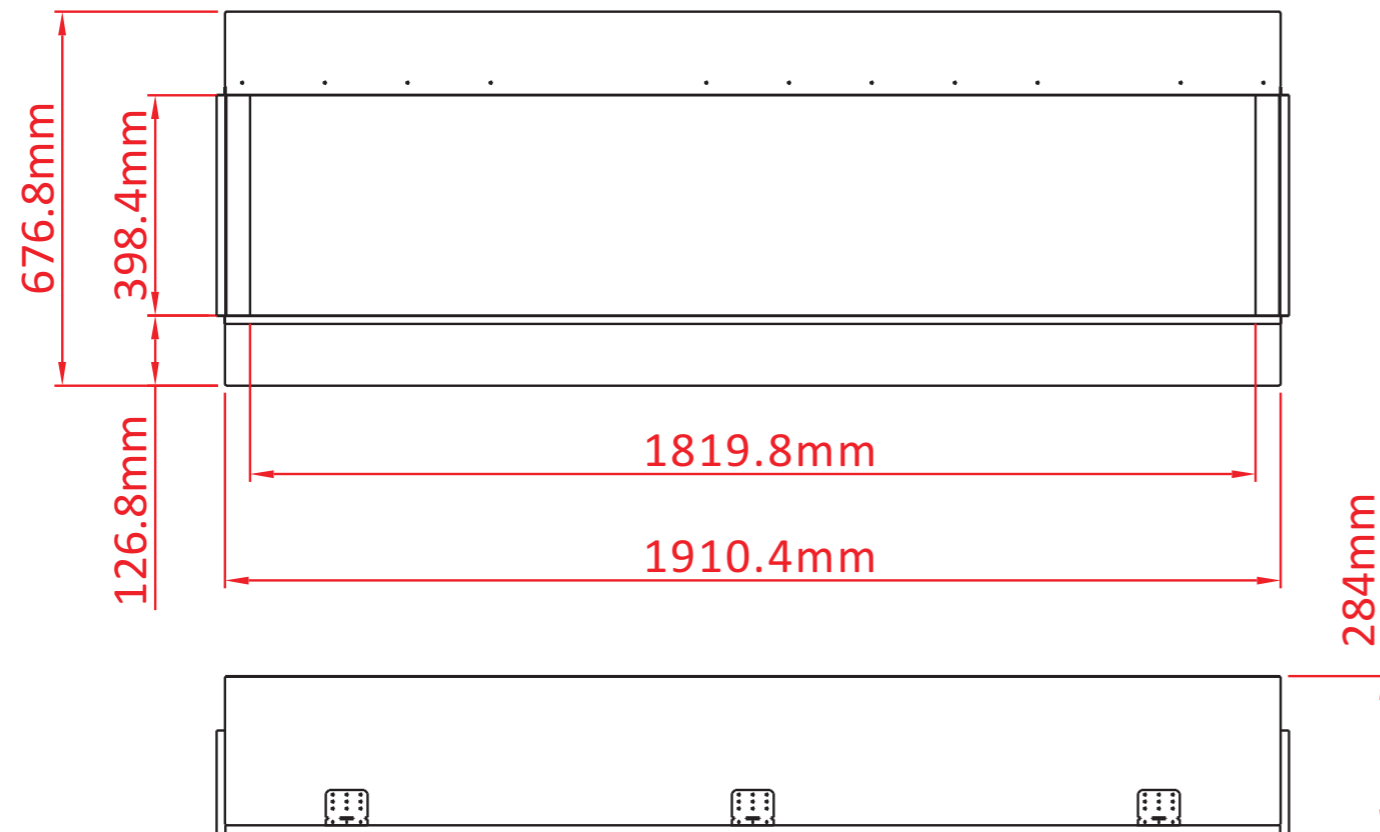

### TECHNICAL SPECIFICATIONS

VOLTS		120
AMPS		12.5
WATTS		1500
HEATER	HIGH	1500 watts
	LOW	750 watts
NO HEATER		19 watts
LAMPS	QUANTITY	LED
	WATTS	
	TOTAL WATTS	19 watts
ROTOR MOTOR		1 at 5 watts
HEIGHT,WIDTH,DEPTH		67.7 x 191 x 26.9 cm
GLASS VIEWING OPENING		39.8 X 182 cm
GLASS SIZE		39.8 X 182 cm
SHIPPING SIZE		74 x 202.1 x 32 cm
SHIPPING WEIGHT		00.0 Kgs
	UNIT	
	GLASS FRONT	Included
PLUG LOCATION		Left Side
CORD LENGTH		193 cm
APPROX. HEATING AREA		37 sqm

*Amantii*

SERIES	MODEL		REV
TRU VIEW	72-TV-SLIM		1
SCALE 1:12	DATE: 9/4/2019	SHEET 1 OF 1	