

27-4.1-CL16

Deck Mounted Bidet Monoblock

Includes MPU7 pop-up drain

Note: Some building codes may require backflow preventers installed in the supply lines

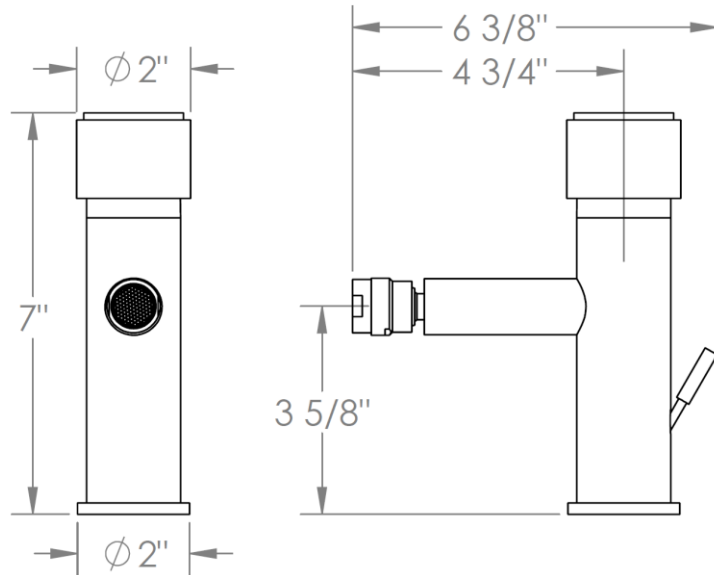

Meets the applicable requirements of ASME A112.18.1-2005/CSA B125.1-05, entitled "Plumbing Supply Fittings"

WATERMARK DESIGNS 1/21/2019

350 Dewitt Ave Brooklyn NY 11207 USA T 718 257 2800 F 718 257 2144 info@watermark-designs.com