

INSTALLER: LEAVE THIS MANUAL WITH THE APPLIANCE.
CONSUMER: RETAIN THIS MANUAL FOR FUTURE REFERENCE.
NEVER LEAVE CHILDREN OR OTHER AT RISK INDIVIDUALS ALONE WITH THE APPLIANCE.



INSTALLATION AND OPERATING INSTRUCTIONS

CERTIFIED UNDER CANADIAN AND AMERICAN NATIONAL STANDARDS: ETL

**CHFP-002/CHFPV-20/CHFP-30B/CHFP-40B/CHFP-50B/CHFP-60B/CHFP-74B/CHFP-74BS/
CHFP-102B/SCW-001/SCW-002/SCW-003/SCI-001/SCI-002/SCI-003/CHFPN-60/CHFPN-74/CHFPN-102**

ELECTRIC FIREPLACE



CHFP-002



CHFPV-20



CHFPN-74, the similar size as CHFPN-60 and CHFPN-102.

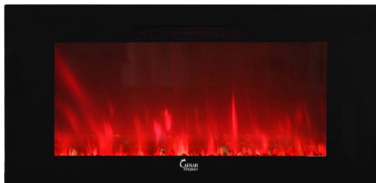

CHFP-50B, the similar size as CHFP-30B, CHFP-40B, CHFP-60B, CHFP-74B, CHFP-74BS and CHFP-102B.

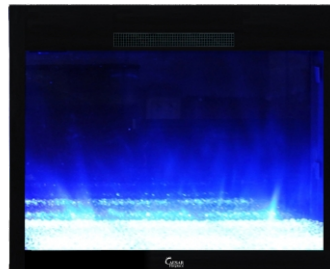

SCI-002, the similar size as SCI-001 and SCI-003.

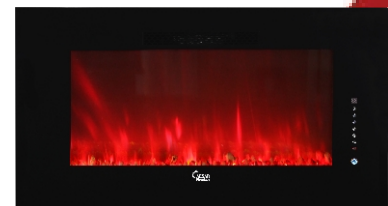

SCW-001, the similar size as SCW-002 and SCW-003.

SAFETY INFORMATION

! WARNING

If the information in these instructions are not followed exactly, a fire may result causing property damage, personal injury or loss of life.



WARNING



HOT GLASS WILL CAUSE BURNS.

DO NOT TOUCH GLASS UNTIL COOLED.

NEVER ALLOW CHILDREN TO TOUCH GLASS.

Quality System Certified To
ISO
9001-2008

CE

ROHS

ETL LISTED US

19295 E. Walnut Dr N, City of Industry, CA 91748

Phone 1-800-306-3829 • Fax (626) 453-0409 • www.caesarfireplace.com • sales@caesarhardware.com

TABLE OF CONTENTS

1.0	PACKING LIST	3
2.0	WELCOME & CONGRATULATIONS	4
3.0	INTRODUCTION	4
	3.1 DIMENSIONS	5
	3.2 LISTING APPROVALS	5
	3.3 GENERAL INSTRUCTIONS	7
4.0	PLACING APPLIANCE	8
	4.1 UNPACKING AND TESTING APPLIANCE	8
	4.2 GROUNDING APPLIANCE	8
5.0	INSTALLATION	9
	5.1 WALL-MOUNT INSTALLATION	10
	5.1.1 WALL-MOUNT INSTALLATION METHOD FOR CHFPV-20 AND SCW SERIES	10
	5.1.2 WALL-MOUNT INSTALLATION METHOD FOR CHFP-xxB AND CHFP-74BS	11
	5.2 RECESSED INSTALLATION	12
	5.2.1 INSTALLATION METHOD FOR SCW SERIES	12
	5.2.2 INSTALLATION METHOD FOR CHFP-xxB AND CHFP-74BS	12
	5.3 FREE STANDING INSTALLATION	13
6.0	FINISHING	14
	6.1 GLASS DOOR REMOVAL	14
	6.1.1 METHOD FOR CHFPV-20 AND SCW SERIES	14
	6.1.2 METHOD FOR CHFP-xxB AND CHFP-74BS	15
	6.2 MEDIA BED KITS INSTALLATION	15
	6.2.1 6 INTERCHANGEABLE MEDIA BED KITS INCLUDED	15
	6.3 GLASS DOOR INSTALLATION	16
	6.3.1 GLASS DOOR INSTALLATION METHOD FOR CHFPV-20 AND SCW SERIES	16
	6.3.2 GLASS DOOR INSTALLATION METHOD FOR CHFP-xxB AND CHFP-74BS	16
7.0	OPERATING INSTRUCTIONS	17
	7.1 MAIN POWER BUTTON	17
	7.1.1 THE BUTTON THAT IS USED FOR CHFP-002	17
	7.1.2 THE BUTTON THAT IS USED FOR CHFPV-20 AND SCW SERIES	17
	7.1.3 THE BUTTON THAT IS USED FOR CHFP-xxB, CHFP-74BS, SCI, AND CHFPN SERIES	17
	7.2 REMOTE CONTROL	18
	7.2.1 BATTERY INSTALLATION	18
	7.2.2 REMOTE OPERATION	18
	7.2.2.1 REMOTE OPERATION FOR CHFPV-20	18
	7.2.2.2 REMOTE OPERATION FOR ALL MODELS EXCEPT CHFPV-20	19
	7.3 LED CONTROL	20
	7.4 CONTROL PANEL	20
	7.4.1 CONTROL PANEL THAT IS USED FOR CHFPV-20 AND SCW SERIES	21
	7.4.2 CONTROL PANEL THAT IS USED FOR CHFP-xxB AND CHFP-74BS	21
	7.4.3 CONTROL PANEL THAT IS USED FOR SCI AND CHFPN SERIES	21
	7.5 INTELLIGENT CONTROL	22
8.0	MAINTENANCE	23
	8.1 PARTIALLY REFLECTIVE GLASS CLEANING	23
	8.2 GLASS DOOR CLEANING	23
	8.3 SERVICING	23
9.0	REPLACEMENT PARTS	24
10.0	TROUBLE SHOOTING	25
11.0	WARRANTY	26

NOTE: Changes, other than editorial, are denoted by a vertical line in the margin.

1.0 PACKING LIST

No	Description	Quantity	Model
1	Electric fireplace	1 pc	CHFP-002, CHFPV-20, CHFP-30B, CHFP-40B, CHFP-50B, CHFP-60B, CHFP-74B, CHFP-74BS, CHFP-102B, SCW-001, SCW-002, SCW-003, SCI-001, SCI-002, SCI-003, CHFPN-60, CHFPN-74, CHFPN-102
2	Installation and operating instructions	1 pc	
3	Remote control (battery included)	1 pc	
4	Stands	2 pcs	CHFP-30B, CHFP-40B, CHFP-50B, CHFP-60B, CHFP-74B, CHFP-74BS, CHFP-102B
5	Wall mount bracket	1 pc	CHFPV-20, CHFP-30B, CHFP-40B, CHFP-50B, CHFP-60B, CHFP-74B, CHFP-74BS, CHFP-102B, SCW-001, SCW-002, SCW-003
6	Backlight	1 pc	CHFP-30B, CHFP-40B, CHFP-50B, CHFP-60B, CHFP-74B, CHFP-74BS, CHFP-102B
7	Wall anchors	3 sets	CHFPV-20
		7 sets	CHFP-30B
		9 sets	SCW-001, CHFP-40B, CHFP-50B
		13 sets	SCW-002, SCW-003, CHFP-60B, CHFP-74B, CHFP-74BS, CHFP-102B
8	Screws	8 pcs	CHFP-30B, CHFP-40B, CHFP-50B, CHFP-60B, CHFP-74B, CHFP-74BS, CHFP-102B
9	Media bed kits	6 sets	CHFPV-20, CHFP-30B, CHFP-40B, CHFP-50B, SCW-001
		12 sets	CHFP-60B, CHFPN-60, CHFP-74B, CHFPN-74, CHFP-74BS, SCI-001, SCW-002, SCW-003
		18 sets	CHFP-102B, SCI-002, SCI-003, CHFPN-102

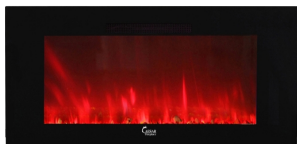

①



②



(For CHFPV-20)

③



(For all models except CHFPV-20)



④



⑥



⑦



⑧



(For CHFPV-20)



(For CHFP-30B)



(For CHFP-40B)



(For SCW-001)



(For CHFP-50B)



(For CHFP-60B)



(For SCW-002 and SCW-003)



(For CHFP-74B and CHFP-74BS)



(For CHFP-102B)

⑤



⑨

2.0 WELCOME & CONGRATULATIONS

Thank you and congratulations for choosing to purchase an electric fireplace from Caesar Fireplace, the world leader in electric fireplaces. To view the full line of Caesar Fireplace products, please visit www.caesarfiredplace.com or our social media website as below:



www.facebook.com/caesarhardware



www.instagram.com/caesarhardware



www.twitter.com/caesarhardware



www.youtube.com/caesarhardware

3.0 INTRODUCTION

WARNING

- **THIS APPLIANCE IS HOT WHEN OPERATED AND CAN CAUSE SEVERE BURNS IF TOUCHED.**
- Do not operate appliance before reading and understanding operating instructions. Failure to operate appliance according to operating instructions could cause fire or injury.
- Risk of burns. Power to the appliance should be turned off and the appliance allowed to cool before servicing. To disconnect power to the appliance, turn controls to off, then remove plug from outlet.
- Do not install damaged, incomplete or substitute components.
- Young children should be carefully supervised when they are in the same room as the appliance. Toddlers, young children and others may be susceptible to accidental contact burns.
- To prevent accidental swallowing, media bed kits should be kept away from children and infants.
- Remote control contains small batteries. Keep away from children. If swallowed, seek medical attention immediately.
- Do not install battery backwards, charge, put in fire or mix with used or other battery types-may explode or leak causing injury.
- Ensure you have incorporated adequate safety measure to protect infants/toddlers from touching hot surfaces.
- It is imperative that the control compartments, circulating blower and its passageway in the appliance and are kept clean. The appliance should be inspected before use and at least annually by a qualified service person.
- Under no circumstances should this appliance be modified.
- Do not use this appliance if any part has been in contact with water. Immediately call a qualified service technician to inspect the appliance and to replace any part of the control system which has been in contact with water.
- Do not operate the appliance with the glass door removed, cracked or broken. Replacement of the glass should be done by a licensed or qualified service person.
- Do not strike or slam shut the appliance glass door.
- Keep the packaging material out of reach of children and dispose of the material in a safe manner. As with all plastic bags, these are not toys and should be kept away from children and infants.
- Servicing should be done only while the appliance is disconnected from the power supply circuit.
- Always unplug appliance when not in use.
- Do not operate this appliance with a damaged cord or plug after the appliance malfunctions, has been dropped or damaged in any manner. Return appliance to authorized service facility for examination, electrical or mechanical adjustment, or repair.
- Do not use appliance outdoors.
- Never place appliance where it may fall into a bathtub or other water container.
- Do not run cord under carpeting. Do not cover cord with throw rugs, runners, etc. Arrange cord away from cluttered area and where it will not be tripped over.
- Connect to properly grounded outlets only.
- Do not insert or allow foreign objects to enter any ventilation or exhaust opening as this may cause an electric shock or fire, or damage the appliance.
- To prevent a possible fire, do not block air intakes or exhaust in any manner. Do not use on soft surfaces, like a carpet, where openings may become blocked.
- Always plug appliances directly into a wall outlet/receptacle. Never use an extension cord or relocatable power tap (outlet/power strip).

3.1 DIMENSIONS

Take the dimensions of CHFP-50B for example.

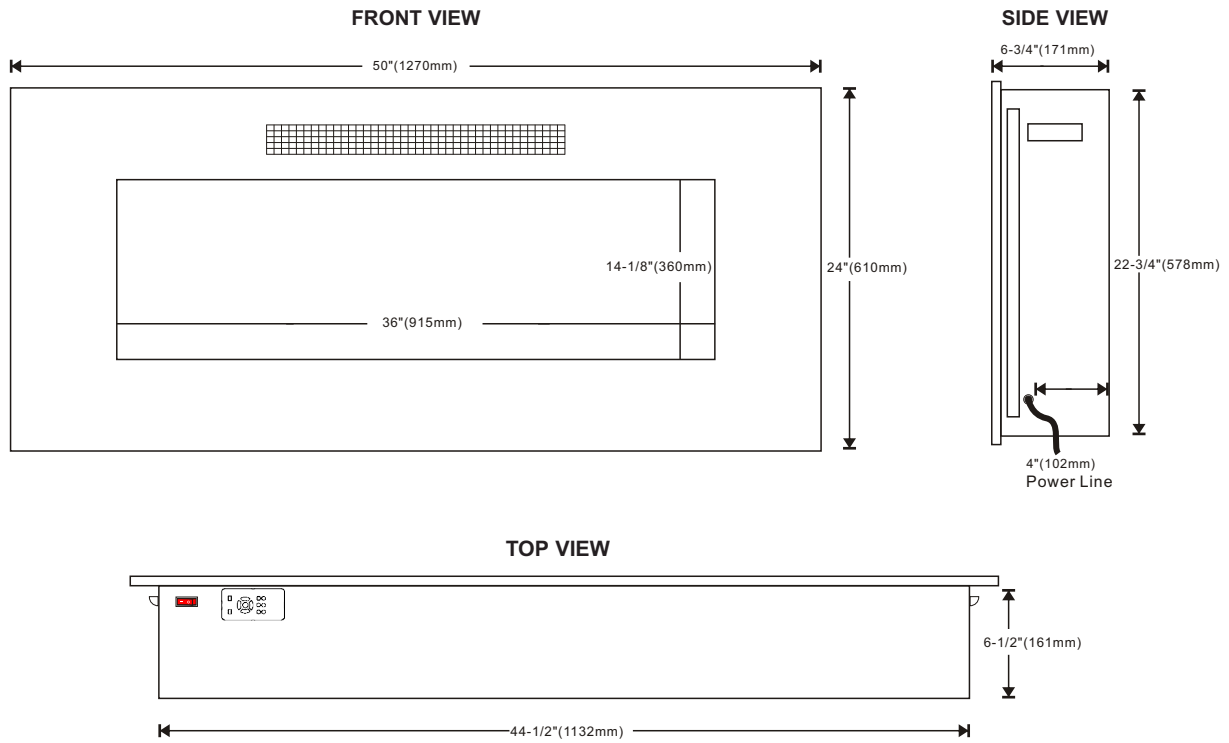

3.2 LISTING APPROVALS

Take the listing approvals of CHFP-50B for example.

This appliance has been tested in accordance with the ETL Standards for fixed and location-dedicated electric room appliances in the United States and Canada. If you need assistance during installation, please contact your local dealer.

NOTE: This appliance must be electrically wired and grounded in accordance with local or, in the absence of local, with National Electric Code ANSI/NFPA 70-latest edition in the United States or the Canaian Electric Code, ETL in Canada.

Model Number	CHFP-50B
Description	Wall-mount, recessed, or free standing Appliance
Voltage	120V AC
Watts	Max 1500W
Amps	13 AMP
Btus	5100 BTU
Appliance Width	50" (1270mm)
Appliance Height	24" (610mm)
Appliance Depth	6-3/4" (171mm)
Net Weight	96 lbs (43kgs)
Gross Weight	100 lbs (45kgs)

Model	Description	Voltage	Watts	Amps	Buts	Appliance Dimensions (W×H×D)
CHFP-002	Infrared mini heater	120VAC	Max 1500W	13AMP	5100BUT	12"×16"×10" (305×406×254mm)
CHFPV-20	Wall-mount appliance					20"×35"×6-3/4" (508×889×171mm)
CHFP-30B	Wall-mount, recessed, or free standing appliance					30"×17"×6-3/4" (762×429×171mm)
CHFP-40B						40"×20"×5-5/8" (1016×510×143mm)
CHFP-50B						50"×24"×6-3/4" (1270×610×171mm)
CHFP-60B						60"×24"×6-3/4" (1524×610×171mm)
CHFP-74B/CHFP-74BS						74"×24"×6-3/4" (1880×610×171mm)
CHFP-102B						102"×24"×6-3/4" (2590×610×171mm)
SCW-001						Wall-mount, or recessed appliance
SCW-002	60"×24"×6-3/4" (1524×610×171mm)					
SCW-003	74"×24"×6-3/4" (1880×610×171mm)					
SCI-001	Recessed appliance					36"×33"×8-7/8" (915×840×225mm)
SCI-002						42"×34"×8-7/8" (1067×864×225mm)
SCI-003						48"×35"×8-7/8" (1219×889×225mm)
CHFPN-60	Narrow appliance					60"×24"×5-7/8" (1524×610×150mm)
CHFPN-74						74"×24"×5-7/8" (1880×610×150mm)
CHFPN-102		102"×24"×5-7/8" (2590×610×150mm)				

Model	Dimensions With Stand Included (W×H×D)	Box Dimensions (W×H×D)	Visible Fire Dimensions (W×H)	N.W (lbs/kgs)	G.W (lbs/kgs)
CHFP-002	/	/	7-7/8"×9-1/2" (200×240mm)	18/8	22/10
CHFPV-20	/	/	13-1/2"×23-1/4" (345×592mm)	45/21	48/22
CHFP-30B	30"×18-1/4"×9-3/4" (762×464×248mm)	27-3/4"×16-3/4"×4" (706×423×102mm)	20-3/4"×10-7/8" (528×276mm)	52/23	54/25
CHFP-40B	40"×21-1/4"×8-5/8" (1016×540×219mm)	34-1/2"×18-1/2"×5-3/8" (877×472×136mm)	26"×11" (660×280mm)	69/31	73/33
CHFP-50B	50"×25-1/4"×9-3/4" (1270×641×219mm)	44-1/2"×22-3/4"×4" (1132×578×102mm)	36"×14-1/8" (915×360mm)	96/43	100/45
CHFP-60B	60"×25-1/4"×9-3/4" (1524×641×219mm)	54-1/2"×22-3/4"×4" (1385×578×102mm)	46"×14-1/8" (1168×360mm)	123/56	132/60
CHFP-74B/CHFP-74BS	74"×25-1/4"×9-3/4" (1880×641×219mm)	68-1/2"×22-3/4"×4" (1740×578×102mm)	60"×14-1/8" (1525×360mm)	150/68	158/72
CHFP-102B	102"×25-1/4"×9-3/4" (2590×641×219mm)	96-1/2"×22-3/4"×4" (2451×578×102mm)	88"×14-1/8" (2234×360mm)	184/83	192/87
SCW-001	/	38-1/2"×18-1/2"×4" (980×472×102mm)	30-3/4"×9" (780×228mm)	84/38	88/40
SCW-002	/	54-1/2"×22-3/4"×4" (1385×578×102mm)	46"×14-1/8" (1168×360mm)	119/54	128/58
SCW-003	/	68-1/2"×22-3/4"×4" (1740×578×102mm)	60"×14-1/8" (1525×360mm)	143/65	152/69
SCI-001	/	34-3/8"×31-7/8"×8-5/8" (874×810×220mm)	32-7/8"×30-5/8" (836×778mm)	65/29	72/32
SCI-002	/	40-1/2"×33"×8-5/8" (1029×836×219mm)	38"×25-3/8" (967×644mm)	86/39	95/43
SCI-003	/	44-3/8"×33-7/8"×8-5/8" (1128×861×219mm)	44"×26-3/8" (1120×669mm)	107/49	116/53
CHFPN-60	/	56-1/2"×20-1/2"×5-1/8" (1436×521×130mm)	56"×20" (1424×510mm)	87/40	95/43
CHFPN-74	/	70-1/2"×20-1/2"×5-1/8" (1792×521×130mm)	70-1/8"×20" (1782×510mm)	103/47	111/50
CHFPN-102	/	98-1/2"×20-1/2"×5-1/8" (2500×522×130mm)	98-3/8"×18-1/4" (2498×464mm)	145/66	154/70

3.3 GENERAL INSTRUCTIONS

 WARNING
READ THESE INSTRUCTIONS COMPLETELY BEFORE BEGINNING INSTALLATION. FAILURE TO FOLLOW THEM COULD CAUSE AN APPLIANCE MALFUNCTION RESULTING IN SERIOUS INJURY AND/OR PROPERTY DAMAGE.
ALL ELECTRIC APPLIANCES HAVE HOT AND ARCING OR SPARKING PARTS INSIDE.
DO NOT OPEN. RISK OF ELECTRIC SHOCK. NO USER-SERVICEABLE PARTS INSIDE.
DO NOT USE DAMAGED ELECTRICAL CORDS.
SERVICING SHOULD BE DONE ONLY WHILE THE APPLIANCE IS DISCONNECTED FROM THE POWER SUPPLY CIRCUIT.
TO PREVENT ELECTRIC SHOCK MATCH THE WIDE BLADE OF PLUG TO WIDE SLOT OF RECEPTACLE AND FULLY INSERT.

- A. Prior to plugging your appliance into an electrical outlet, verify that the house circuit breakers for the outlet are on.
- B. The appliance may emit a slight, harmless odor when first used. This odor is normal and it is caused by the initial heating of internal appliance elements and will not occur again.
- C. If your appliance does not emit heat, consult the operation section of this manual for further information.
- D. Use with a ETL or UL certified surge protector.

This electric appliance meets the construction and safety standards of H.U.D. for application in manufactured homes when installed according to these instructions.

4.0 PLACING APPLIANCE

! WARNING	
NEVER PLACE THIS ELECTRIC APPLIANCE WHERE IT MAY FALL INTO A BATHTUB OR OTHER WATER CONTAINER.	
WEAR SAFETY GLOVES AND SAFETY GLASSES FOR PROTECTION DURING INSTALLATION AND MAINTENANCE.	
TO PREVENT CONTACT WITH SAGGING OR LOOSE INSULATION, THE ELECTRIC APPLIANCE MUST NOT BE INSTALLED AGAINST VAPOR BARRIER OR EXPOSED INSULATION. LOCALIZED OVERHEATING COULD OCCUR AND A FIRE COULD RESULT.	
DO NOT EXPOSE THE ELECTRIC APPLIANCE TO ELEMENTS, SUCH AS RAIN, ETC.	

4.1 UNPACKING AND TESTING APPLIANCE

Carefully remove the appliance from the box. Prior to installing the appliance, test to make sure the appliance operates properly by plugging the power supply cord into a conveniently located 120 Volt grounded outlet.

4.2 GROUNDING APPLIANCE

This appliance is for use on 120 Volts. The cord has a plug as shown in (A). An adapter as shown in (C) is available for connecting three-blade grounding type plugs to two-slot receptacles. The green grounding lug extending from the adapter must be connected to a permanent ground such as a properly grounded outlet box. The adapter should not be used if a three-slot grounded receptacle is available.

To disconnect appliance, turn controls to off, then remove plug from outlet.

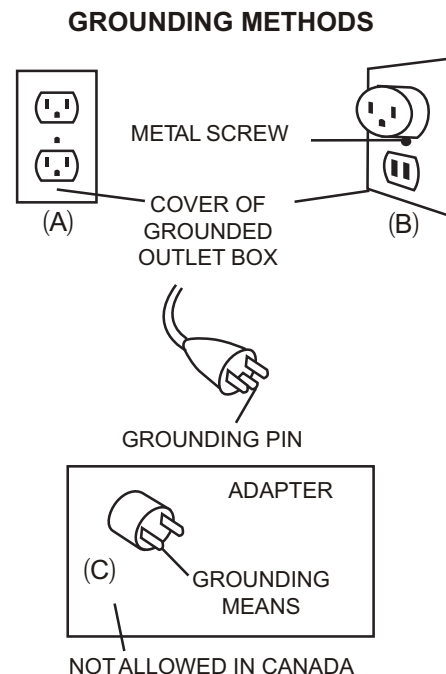

5.0 INSTALLATION

WARNING

RISK OF FIRE! THE POWER CORD MUST NOT BE PINCHED AGAINST A SHARP EDGE. SECURE CORD TO AVOID TRIPPING OR SNAGGING TO REDUCE THE RISK OF FIRE, ELECTRIC SHOCK OR PERSONAL INJURY. DO NOT RUN CORD UNDER CARPETING. DO NOT COVER CORD WITH THROW RUGS, RUNNERS, ETC. ARRANGE CORD AWAY FROM CLUTTERED AREAS AND WHERE IT WILL NOT BE TRIPPED OVER.

RISK OF FIRE. TO PREVENT A POSSIBLE FIRE, DO NOT BLOCK AIR INTAKE OR EXHAUST IN ANY MANNER. DO NOT USE ON SOFT SURFACES WHERE OPENINGS MAY BECOME BLOCKED.

RISK OF FIRE. DO NOT BLOW OR PLACE INSULATION AGAINST THE APPLIANCE.

THIS ELECTRIC APPLIANCE IS TESTED AND LISTED FOR USE ONLY WITH THE APPROVED OPTIONAL ACCESSORIES. USE OF OPTIONAL ACCESSORIES NOT SPECIFICALLY TESTED FOR THIS ELECTRIC APPLIANCE COULD VOID THE WARRANTY AND/OR RESULT IN A SAFETY HAZARD.

IF THE INFORMATION IN THESE INSTRUCTIONS IS NOT FOLLOWED EXACTLY, A FIRE MAY RESULT CAUSING PROPERTY DAMAGE, PERSONAL INJURY OR DEATH. DO NOT STORE OR USE GASOLINE OR OTHER FLAMMABLE VAPORS IN THE VICINITY OF THIS OR ANY OTHER APPLIANCE.

THIS APPLIANCE IS HEAVY. IT IS HIGHLY RECOMMENDED THAT TWO PEOPLE INSTALL THIS APPLIANCE.

HEATER VENTS ON THE ELECTRIC APPLIANCE CANNOT, IN ANY WAY, BE COVERED. AS IT MAY CREATE A FIRE HAZARD.

NOTE: Follow all National and local electrical codes.

5.1 WALL-MOUNT INSTALLATION

Due to the many different materials used on different walls, it is highly recommended that you consult your local builder before you install this appliance on the wall.

5.1.1 WALL-MOUNT INSTALLATION METHOD FOR CHFPV-20 AND SCW SERIES

NOTE: Wall-mount installation method for CHFPV-20, SCW-001, SCW-002, and SCW-003.

Below is the illustration of SCW-001, for the wall mount bracket and the quantity of wall anchors that be used for other models, please see page3.

- Have two people hold the appliance against the wall to determine the final location.
- Mark out location, then mount the bracket onto the wall using the five supplied screws. This bracket **MUST** have the hooks facing upward and be leveled.

NOTE: It is strongly recommended that the mounting bracket be screwed into the wall studs where possible. If the wall studs cannot be used, ensure that the supplied plastic anchors are used to affix the bracket to the wall and the bracket is adequately secured.
- With the wall mounting bracket installed, have two people lift the appliance up and insert the two hooks on the bracket into the two slots on the back of the appliance.
- Check the appliance for stability, ensuring that the bracket will not break free from the wall.

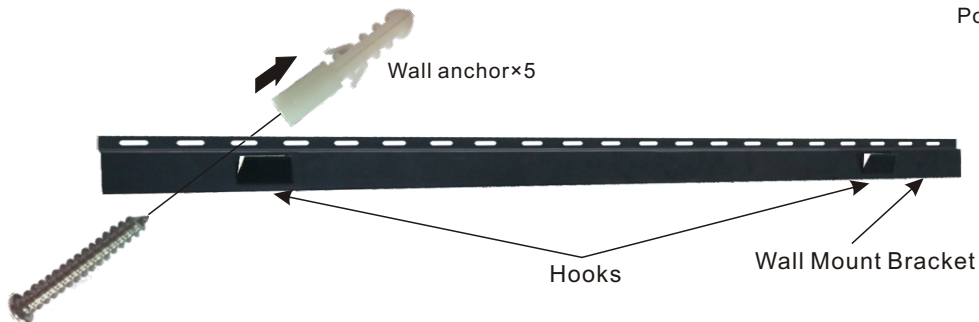
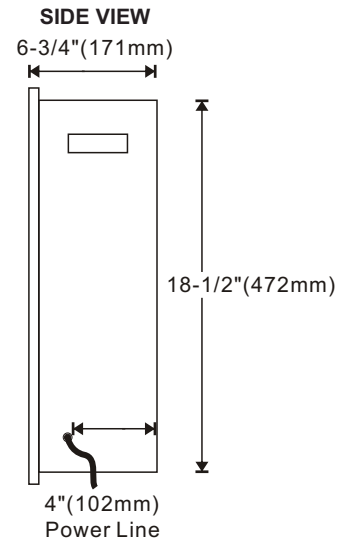

REAR VIEW

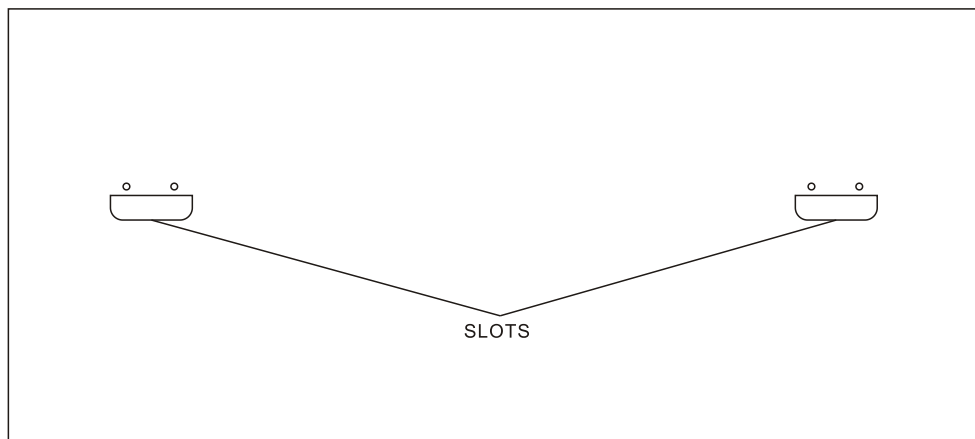

5.1.2 WALL-MOUNT INSTALLATION METHOD FOR CHFP- $\times\times$ B AND CHFP-74BS

NOTE: Wall-mount installation method for CHFP-30B, CHFP-40B, CHFP-50B, CHFP-60B, CHFP-74B, CHFP-74BS, and CHFP-102B. Below is the illustration of CHFP-50B, for the wall mount bracket and the quantity of wall anchors that be used for other models, please see page3.

- A. Have two people hold the appliance against the wall to determine the final location.
- B. Mark out location, then mount the bracket onto the wall using the five supplied screws. This bracket MUST have the holes for screws facing downward and be leveled.

NOTE: It is strongly recommended that the mounting bracket be screwed into the wall studs where possible. If the wall studs cannot be used, ensure that the supplied plastic anchors are used to affix the bracket to the wall and the bracket is adequately secured.
- C. With the wall mounting bracket installed, have two people lift the appliance up and hang the appliance on the bracket.
- D. Check the appliance for stability, ensuring that the bracket will not break free from the wall.

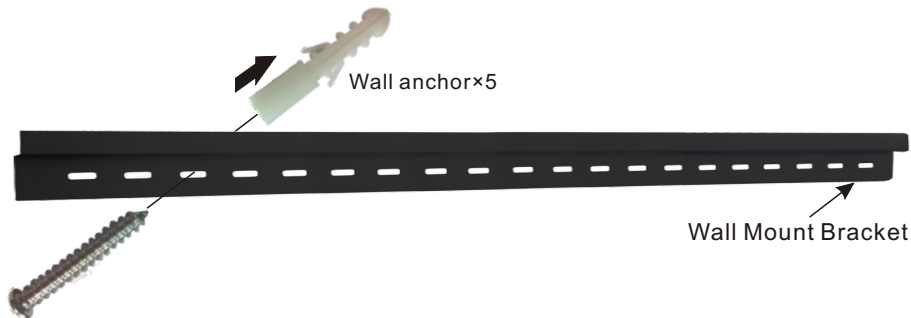
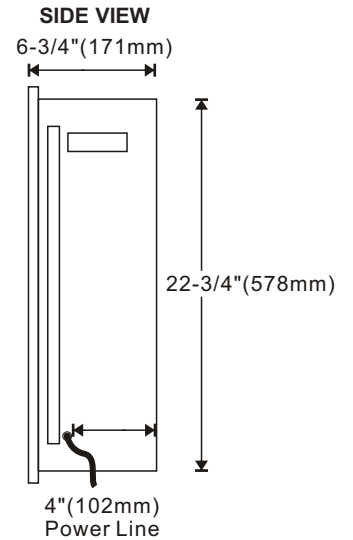

REAR VIEW



5.2 RECESSED INSTALLATION

5.2.1 INSTALLATION METHOD FOR SCW SERIES

NOTE: Installation method for SCW-001, SCW-002 and SCW-003. Below is the illustration of SCW-001, for the quantity of wall anchors that be used for other models, please see page3.

- Leave a box in the wall, the size is W38-1/2"×H18-1/2"×D4".
- Have two people put the box into the wall, and fix the box to the wall with self-tapping screws.
- Put the hooks on the both sides of glass door into the holes in the box. Then push down the glass door to its place.
- Check the appliance for stability, ensuring that the appliance will not break free from the wall.

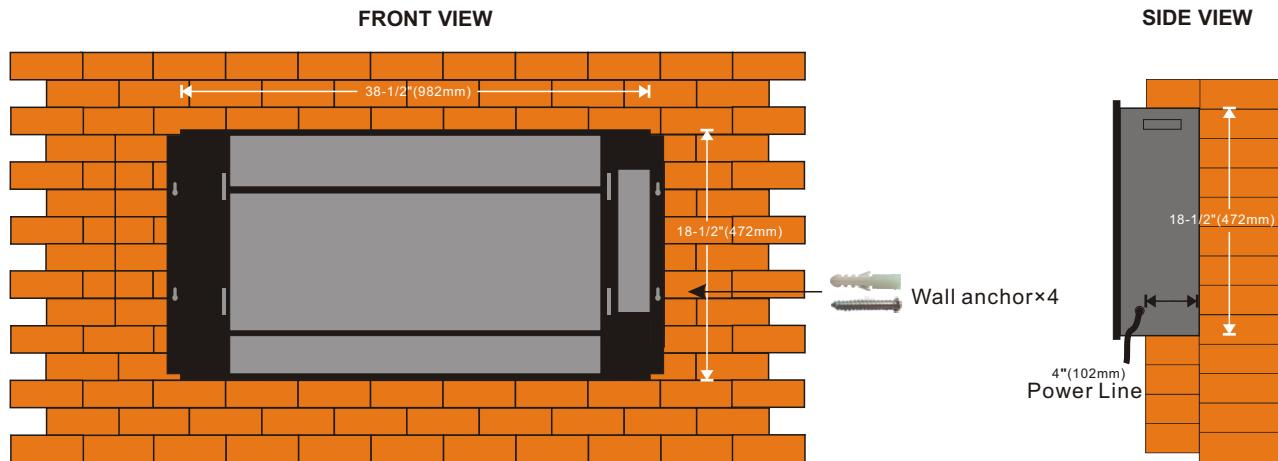

5.2.2 INSTALLATION METHOD FOR CHFP-x×B AND CHFP-74BS

NOTE: Installation method for CHFP-30B, CHFP-40B, CHFP-50B, CHFP-60B, CHFP-74B, CHFP-74BS, and CHFP-102B. Below is the illustration of CHFP-50B, for the quantity of wall anchors that be used for other models, please see page3.

- Leave a box in the wall, the size is W44-1/2"×H22-3/4"×D4".
- Have two people put the box into the wall, and fix the box to the wall by adjusting side steel plate with self-tapping screws.
- Put the hooks on the both sides of glass door into the holes in the box. Then push down the glass door to its place.
- Check the appliance for stability, ensuring that the appliance will not break free from the wall.

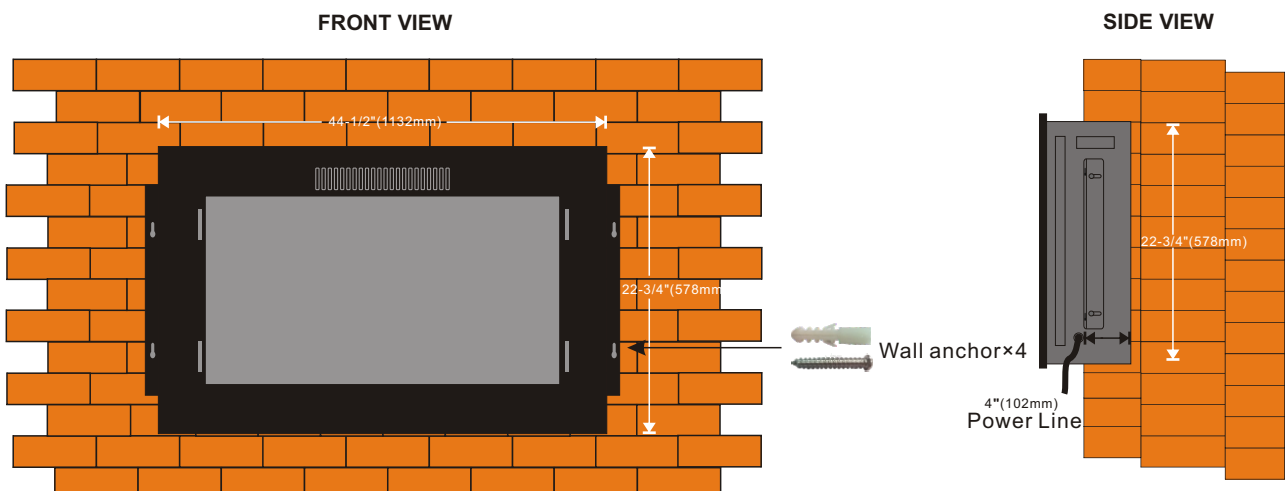

5.3 FREE STANDING INSTALLATION

NOTE: Only for CHFP-30B, CHFP-40B, CHFP-60B, CHFP-74B, CHFP-74BS, and CHFP-102B can be installed free standing. Below is the illustration of CHFP-50B.

- A. Upend the box, then fix the stand with 4 screws at each side, as shown in the figure (A). Base installation is finished.
- B. Put the hooks on the both sides of glass door into the holes in the box. Then push down the glass door to its place.

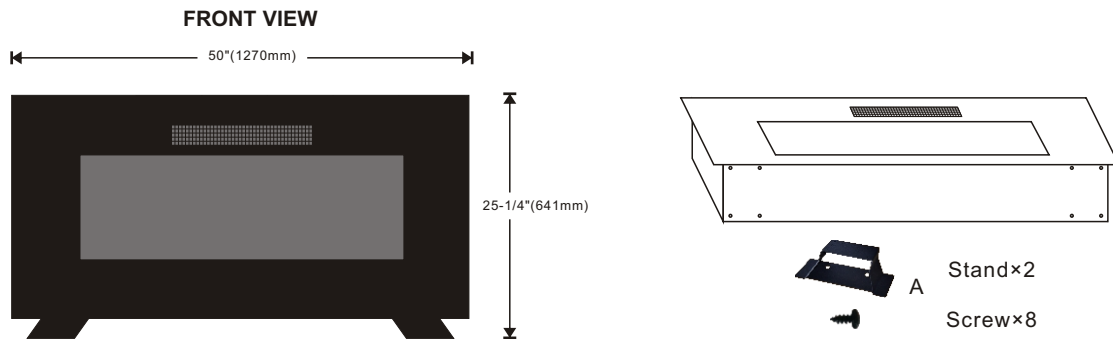

6.0 FINISHING

! WARNING

POWER SUPPLY SERVICE MUST BE COMPLETED PRIOR TO FINISHING TO AVOID RECONSTRUCTION.

HEAT VENTS AND AIR OPENINGS CANNOT BE COVERED IN ANY CIRCUMSTANCES.

6.1 GLASS DOOR REMOVAL

! WARNING

GLASS MAY BE HOT, DO NOT TOUCH GLASS UNTIL COOLED.

THE DOOR HOOKS ARE PART OF A SAFETY SYSTEM AND MUST BE PROPERLY ENGAGED. DO NOT OPERATE THE APPLIANCE WITH HOOKS DISENGAGED.

FACING AND/OR FINISHING MATERIALS MUST NOT INTERFERE WITH AIR FLOW THROUGH AIR OPENINGS, OPERATION OF OR DOORS OR ACCESS FOR SERVICE. OBSERVE ALL CLEARANCES WHEN APPLYING COMBUSTIBLE MATERIALS.

BEFORE DOOR IS REMOVED TURN THE APPLIANCE OFF AND WAIT UNTIL APPLIANCE IS COOL TO THE TOUCH. DOORS ARE HEAVY AND FRAGILE SO HANDLE WITH CARE.

6.1.1 METHOD FOR CHFPV-20 AND SCW SERIES

Below is the illustration of CHFPV-20.

- A. Two people to hold the glass door and lift the door until it's out of the holes.
- B. To disconnect the data line and power line, press the plastic connector, then pull them out.

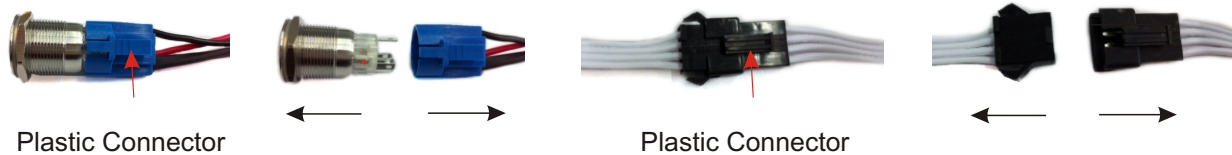

- C. Remove the glass door from appliance.

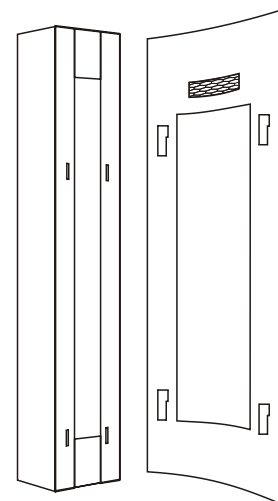
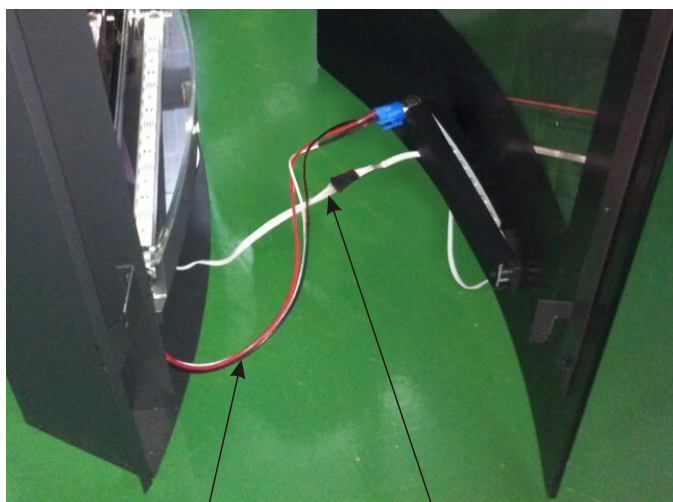

6.1.2 METHOD FOR CHFP-xxB AND CHFP-74BS

- A. Two people to hold the glass door and lift the door until it's out of the holes.
- B. Remove the glass door from appliance.



6.2 MEDIA BED KITS INSTALLATION

NOTE: Glass front must be removed and the appliance must be finished in its final location before the media bed kits are installed. Media bed kits may have sharp edges, wear safety glasses and gloves when handling.

Carefully place media bed kits into the bottom tray on the front of the appliance as illustrated. Apply an even layer from side to side.

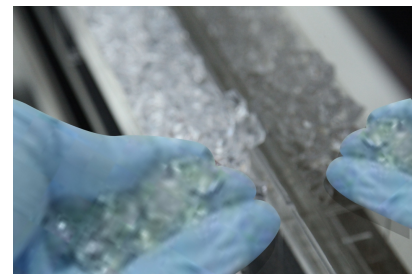

6.2.1 6 INTERCHANGEABLE MEDIA BED KITS INCLUDED



Morocco Dream

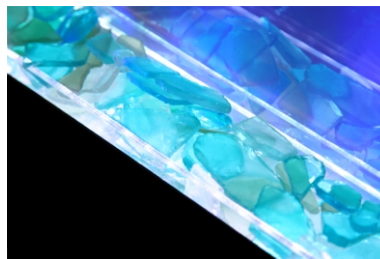

Winter Flakes

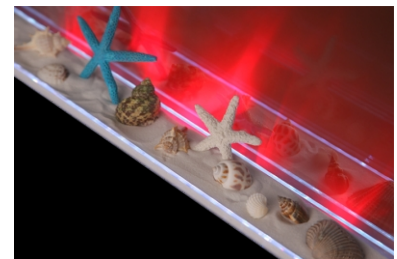

Tahiti Getaway



Falling Stars

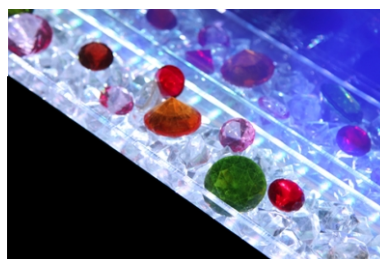

Glamour Night



Treasure Hunt

Model	CHFPV-20/CHFP-30B/CHFP-40B/CHFP-50B/SCW-001					
Media kits	Falling Stars	Glamour Night	Winter Flakes	Treasure Hunt	Morocco Dream	Tahiti Getaway (1 bag of soft sand included)
Quantity	1 box	1 box	1 box	1 box	1 box	1 box

Model	CHFP-60B/ CHFP-74B/CHFP-74BS/SCW-002/SCW-003/CHFPN-60/CHFPN-74/SCI-001					
Media kits	Falling Stars	Glamour Night	Winter Flakes	Treasure Hunt	Morocco Dream	Tahiti Getaway (2 bags of soft sand included)
Quantity	2 boxes	2 boxes	2 boxes	2 boxes	2 boxes	2 boxes

Model	CHFP-102B/SCI-002/SCI-003/CHFPN-102					
Media kits	Falling Stars	Glamour Night	Winter Flakes	Treasure Hunt	Morocco Dream	Tahiti Getaway (2 bags of soft sand included)
Quantity	3 boxes	3 boxes	3 boxes	3 boxes	3 boxes	3 boxes

6.3 GLASS DOOR INSTALLATION

6.3.1 GLASS DOOR INSTALLATION METHOD FOR CHFPV-20 AND SCW SERIES

- A. To connect power line, align the plastic connector and red dot, then connect data line.
- B. Two people to hold the glass door and put the hooks into the holes.
- C. Check the glass door for stability, ensuring the hooks will not break free from the holes.

6.3.2 GLASS DOOR INSTALLATION METHOD FOR CHFP-xxB AND CHFP-74BS

- A. Two people to hold the glass door and put the hooks into the holes.
- B. Check the glass door for stability, ensuring the hooks will not break free from the holes.

7.0 OPERATING INSTRUCTIONS

Once the appliance has been plugged into a grounded electrical outlet, it is ready to operate.

7.1 MAIN POWER BUTTON

7.1.1 THE BUTTON THAT IS USED FOR CHFP-002

The Main Power Button is located at the back of the heater. Press this button to position "-" to turn on the appliance, the backlight will be lighted up, press "O" side turns it off.

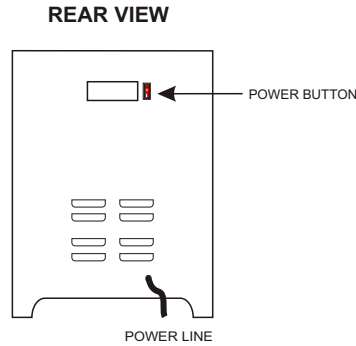

7.1.2 THE BUTTON THAT IS USED FOR CHFPV-20 AND SCW SERIES

The Main Power Button is located on the right of the control panel as illustrated. Press this button to turn on the appliance. Press again and the button will bounce back. The appliance is turned off.

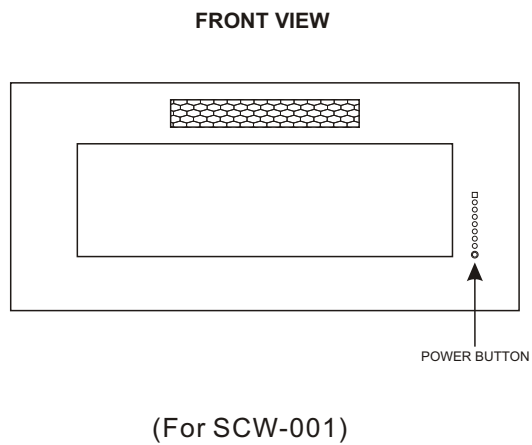
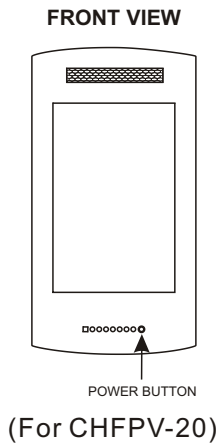

7.1.3 THE BUTTON THAT IS USED FOR CHFP-xxB, CHFP-74BS, SCI, AND CHFPN SERIES

The Main Power Button is located on the right top of the fireplace as illustrated. Press this button to position "-" to turn on the appliance, the backlight will be lighted up, press "O" side turns it off.

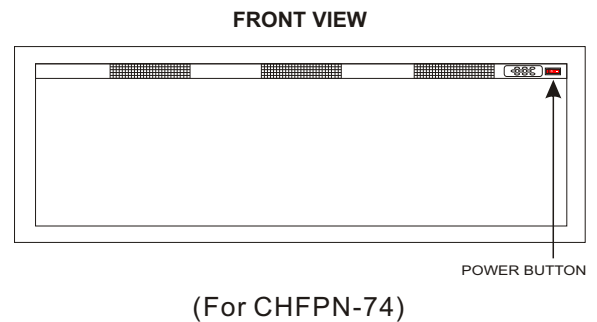
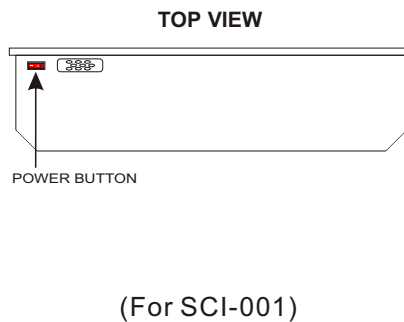
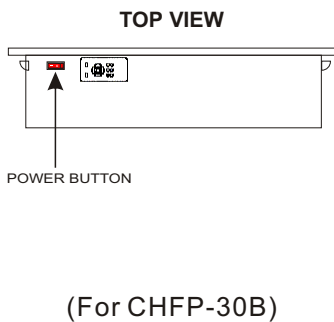

7.2 REMOTE CONTROL

7.2.1 BATTERY INSTALLATION

- A. Pulling the battery holder out of the slot remote.
- B. Install the battery. It uses CR 2032 battery.
- C. Reinstall the battery holder into the remote by sliding it into position, as shown.







Battery must be recycled or disposed of properly. Check with your Local Authority or Retailer for recycling advice in your area.





7.2.2 REMOTE OPERATION

NOTE: Make certain new batteries are installed correctly and the appliance turned on! The remote control will NOT work if the Main Power Switch is NOT pressed down. When operating the remote control, it must be directed towards the right of appliance.







7.2.2.1 REMOTE OPERATION FOR CHFPV-20

- A. Plug in your electric appliance.
- B. Press "POWER"  button, the appliance is on standby mode.
- C. The "ON/OFF"  button can be used to power up or down the appliance. Pressing this button activates the power to the appliance. Long-press this button for 6 seconds, then after a beep, heating function will be locked, the backlight of this button will be off. Also long-press for 6 seconds again to unlock heating function. Under the locked mode, "HEAT"  button is not available.
- D. To change flame color, press the "COLOR A"  button. There are 3 colors to choose from, red, yellow, and blue. The indicator will show digital "1" to "3" when changing colors. When you press the button for 3 seconds until you hear a beep, the indicator will show digital "0", the flame color and brightness will be changed automatically.
- E. To change flame bed color, press the "COLOR B"  button. There are 7 colors to choose from, blue, red, purple, green, cyan, yellow, and white. The indicator will show digital "1" to "7" when changing colors. When you press the button for 3 seconds until you hear a beep, the indicator will show digital "0", the flame bed color and brightness will be changed automatically.









- F. To change brightness, press the "DIMMER"  button. There are 5 adjustments to choose from. The indicator will show "L1" to "L5" when pressing this button.
- G. To change flame speed, press the "SPEED"  button. There are 5 speeds to choose from. The indicator will show "V1" to "V5" when pressing this button.
- H. Under the unlock mode, to activate the heater, press the "HEAT"  button. The initial set-up heat level will be set for low heat (750W), the indicator will show "-". To adjust the heat level press again for high heat (1500W), the indicator will show "--". Press it for the third time, then the mechanism will stop function. After 10 seconds, the indicator will show "OF".
- I. Press "TIMER"  button, this sets the timing for switching the fireplace off automatically. The timer ranges from 1 to 8 hours, which will be shown on the indicator from "1H" to "8H". Timer is turned off when the indicator shows "0H". If the appliance is restarted, timer also needs to be reset again.
- J. When you turn on the appliance, all the backlight will be lighted up. Do not press any button for 20 seconds, all the backlight will be off.
- K. Press the "ON/OFF"  button to turn off the appliance.

7.2.2.2 REMOTE OPERATION FOR ALL MODELS EXCEPT CHFPV-20

- A. Plug in your electric appliance.
- B. Press "POWER"  button at "-" side, the appliance is on standby mode.
- C. The "ON/OFF"  button can be used to power up or down the appliance. Pressing this button activates the power to the appliance. Long-press this button for 6 seconds, then after a beep, heating function will be locked. Also long-press for 6 seconds again to unlock heating function. Under the locked mode, "HEAT"  button is not available.
- D-1. To change flame color, press the "FLAME"  button. There are 12 colors to choose from, red, yellow, blue, white, red & yellow, red & blue, red & white, yellow & blue, yellow & white, blue & white, red & yellow & blue, multicolor. The indicator will show digital "1" to "9" and "A" to "C" when changing colors. When you press the button for 3 seconds until you hear a beep, the indicator will show digital "0", the flame color and brightness will be changed automatically. (For CHFP-002, CHFP-xxB, CHFP-74BS, SCI, and CHFPN series)
- D-2. To change flame color, press the "FLAME"  button. There are 5 colors to choose from, red, yellow, blue, white, and multicolor. The indicator will show digital "1" to "5" when changing colors. When you press the button for 3 seconds until you hear a beep, the indicator will show digital "0", the flame color and brightness will be changed automatically. (For SCW series)
- E-1. To change flame bed color, press the "FLAME BED"  button. There are 12 colors to choose from, red, white, green, blue, purple, cyan, yellow, orange, saffron, golden, verdant, and lavender. The indicator will show digital "1" to "9" and "A" to "C" when changing colors. When you press the button for 3 second until you hear a beep, the indicator will show digital "0", the flame bed color and brightness will be changed automatically. (For CHFP-002, CHFP-xxB, CHFP-74BS, SCI, and CHFPN series)
- E-2. To change flame bed color, press the "FLAME BED"  button. There are 5 colors to choose from, red, yellow, blue, white, and multicolor. The indicator will show digital "1" to "5" when changing colors. When you press the button for 3 seconds until you hear a beep, the indicator will show digital "0", the flame bed color and brightness will be changed automatically. (For SCW series)





- F. To change brightness, press the "DIMMER"  button. There are 5 adjustments to choose from. The indicator will show "L1" to "L5" when pressing this button.
- G. To change flame speed, press the "SPEED"  button. There are 5 speeds to choose from. The indicator will show "V1" to "V5" when pressing this button.
- H-1. Under the unlock mode, to activate the heater, press the "HEAT"  button. The initial set-up heat level will be set for low heat (750W), the indicator will show "-". To adjust the heat level press again for high heat (1500W), the indicator will show "--". Press it for the third time, then the mechanism will stop function. After 10 seconds, the indicator will show "OF". (For CHFP-xxB, CHFP-74BS, SCI-001, SCI-002, SCW, and CHFPPN series)
- H-2. Under the unlock mode, to activate the infrared heater, press the "HEAT"  button. The initial set-up heat level will be set for low heat (750W), the indicator will show "-". To adjust the heat level press again for high heat (1500W), the indicator will show "--". Press it for the third time, then the mechanism will stop function. After 10 seconds, the indicator will show "OF". (For CHFP-002 and SCI-003)
- I. Press "TIMER"  button, this sets the timing for switching the fireplace off automatically. The timer ranges from 1 to 8 hours, which will be shown on the indicator from "1H" to "8H". Timer is turned off when the indicator shows "0H". If the appliance is restarted, timer also needs to be reset again.
- J. Press  button to set room temperature. Press + to heat up, press - to cool down. (It is inapplicable to SCW series)
- K. Press the "ON/OFF"  button to turn off the appliance.

NOTE: This remote control must remain within 8 meters or 26 feet of the appliance to be effective and this range may be reduced as the battery power is depleted.

7.3 LED CONTROL

NOTE: It is applicable to CHFP-30B, CHFP-40B, CHFP-50B, CHFP-60B, CHFP-74B, CHFP-74BS, and CHFP-102B.

- A. The  button can be used to power up or down the backlight.
- B. To change backlight, press the  button. There are 7 colors to choose from, yellow, red, blue, white, green, cyan, and purple.
- C. To change brightness, press the  button. There are 5 adjustments to choose from.

7.4 CONTROL PANEL

NOTE: Control panel is the same as remote control.

7.4.1 CONTROL PANEL THAT IS USED FOR CHFPV-20 AND SCW SERIES



(For CHFPV-20)

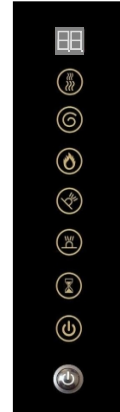

(For SCW series)

7.4.2 CONTROL PANEL THAT IS USED FOR CHFP-xxB AND CHFP-74BS



7.4.3 CONTROL PANEL THAT IS USED FOR SCI AND CHFPN SERIES

NOTE: It is used for SCI-001, SCI-002, SCI-003, CHFPN-60, CHFPN-74, and CHFPN-102.



7.5 INTELLIGENT CONTROL

- A. Scan QR code to get the APP, download and install it.



- B. Turn on the fireplace and make sure that the smart phone or tablet and fireplace are under the same WIFI.
- C. Click the icon  to open the software, then click "Add" to connect WIFI and press "Start" to configure your device in 60 seconds.



- D. When configure succeed, it opens e-remote device list, then click the icon  to enter the software. If you match several fireplaces with the same smart phone or tablet, you can choose the software sequentially. The first line in the e-remote device list is the one that be matched at first.



- E. Intelligent control functions the same way as the remote control.

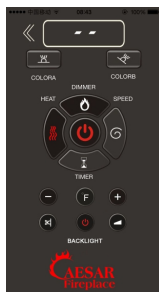

8.0 MAINTENANCE

WARNING

DISCONNECT POWER AND ALLOW HEATER TO COOL BEFORE ATTEMPTING ANY MAINTENANCE OR CLEANING TO REDUCE THE RISK OF FIRE, ELECTRIC SHOCK OR DAMAGE TO PERSON.

THE FIREPLACE SHOULD NOT BE OPERATED WITH AN ACCUMULATION OF DUST OR DIRT ON OR IN THE UNIT, AS THIS CAN CAUSE A BUILD UP OF HEAT AND SUBSEQUENT EVENTUAL DAMAGE. FOR THIS REASON THE HEATER MUST BE INSPECTED REGULARLY, DEPENDING ON CONDITIONS AND AT LEAST AT YEARLY INTERVALS.

8.1 PARTIALLY REFLECTIVE GLASS CLEANING

The partially reflective glass is cleaned in the factory during the assembly operation. During shipment, installation, handling, etc., the partially reflective glass may collect dust particles; these can be removed by dusting lightly with a clean dry cloth.

To remove fingerprints or other marks, the partially reflective glass can be cleaned with a damp cloth. The partially reflective glass should be completely dried with a lint-free cloth to prevent water spots. To prevent scratching, do not use abrasive cleaners.

8.2 GLASS DOOR CLEANING

Use only a damp cloth to clean glass door of the fireplace. Do not use abrasive cleaners.

8.3 SERVICING

Except for installation and cleaning described in this manual, an authorized service representative should perform any other servicing.

9.0 REPLACEMENT PARTS

Take the replacement parts of CHFP-50B for example.

Contact your dealer or the factory for questions concerning prices and policies on replacement parts. Normally all parts can be ordered through your Authorized dealer/distributor.

FOR WARRANTY REPLACEMENT PARTS, A PHOTOCOPY OF THE ORIGINAL INVOICE WILL BE REQUIRED TO HONOR THE CLAIM.

When ordering replacement parts always give the following information:

- Model & Serial Number of appliance
- Installation date of appliance
- Part number
- Finish
- Description of part

⚠ WARNING

FAILURE TO POSITION THE PARTS
IN ACCORDANCE WITH THIS
MANUAL OR FAILURE TO USE ONLY
PARTS SPECIFICALLY APPROVED
WITH THIS APPLIANCE MAY
RESULT IN PROPERTY DAMAGE OR
PERSONAL INJURY.

*** IDENTIFIES ITEMS WHICH ARE NOT ILLUSTRATED. FOR FURTHER INFORMATION, CONTACT YOUR AUTHORIZED DEALER.**

For aftermarket sales and service please call 1-800-306-3829

COMPONENTS		
REF NO.	PART NO.	DESCRIPTION
1	CHP-001	LED CIRCUIT BOARD FOR EMBER BED
2	CHP-002	CIRCUIT BOARD
3	CHP-003	BLOWER AND HEATER ASSEMBLY
4	CHP-004	REMOTE CONTROL
5	CHP-005	STAND
6	CHP-006	FRONT GLASS
7	CHP-007	MIRROR GLASS
8	CHP-008	TRANSFORMER
9	CHP-009	REFLECTOR
10	CHP-010	REMOTE RECEIVER
11	CHP-011	BRACKET
12	CHP-012	FUSE
13	CHP-013	BACKLIGHT

NOTE: Care must be taken when removing and disposing of any broken glass or damaged components. Be sure to vacuum up any broken glass from inside the appliance before operation.



①



②



③



④



⑧



⑤



⑥



⑦



⑬



⑨



⑩



⑫



⑬

10.0 TROUBLE SHOOTING

! WARNING

TURN OFF THE APPLIANCE COMPLETELY AND LET COOL BEFORE SERVICING. ONLY A QUALIFIED SERVICE PERSON SHOULD SERVICE AND REPAIR THIS ELECTRIC APPLIANCE.

SYMPTOM	PROBLEM/TEST	SOLUTION
Timer does not work	There is something wrong with the circuit board	Replace the circuit board (CHP-002)
Heater shuts off automatically	Appliance's fuse has blown	Replace the fuse (CHP-012)
	Room is too warm	The heater has a built-in thermostat so it will shut off automatically once the pre-set temperature is reached. It will also turn on automatically if the room temperature drops below the pre-set temperature
Appliance develops noise	Reflector moved in transit	Fix the screws on the mirror glass (CHP-007)
Dim or no flame	LED circuit board is burned out	Replace the LED circuit board (CHP-001)
	There is something wrong with the circuit board	Replace the circuit board (CHP-002)
	Transformer is broken	Replace the transformer (CHP-008)
No warm air coming out of appliance	Room temperature is higher than the appliance setting (if it is set to room temperature)	Set the appliance to a high or low heat setting
	Heater is burnt out	Inspect the blower and heater assembly (CHP-003) and replace it if necessary
Appliance turns off and will not turn on	Appliance has overheated and safety device has caused the thermal switch to disconnect	Unplug the appliance, allow appliance to cool for 15 minutes, then plug it back in
	House circuit breaker has tripped	Reset house circuit breaker
	Appliance's fuse has blown	Replace the fuse(CHP-012)
Remote control does not work	Low batteries	Replace battery in remote control

11.0 WARRANTY

CAESAR FIREPLACE® electric appliances are manufactured under the strict Standard of the world recognized ISO 9001:2008 Quality Assurance Certificate.

CAESAR FIREPLACE® products are designed with superior components and materials, assembled by trained craftsmen who take great pride in their work. Once assembled the complete appliance is thoroughly inspected by a qualified technician before packing to ensure that you, the customer, receive the quality product that you expect from CAESAR FIREPLACE®.

CAESAR FIREPLACE® ELECTRIC APPLIANCE LIMITED WARRANTY

Electrical components and wearable parts such as fan/heater, motors, switches, nylon bearing components and remote controls are covered and CAESAR FIREPLACE® will provide replacement parts free of charge during the first year of limited warranty.
Light bulbs and fuses are NOT covered by the warranty.
Any labor related to warranty repair is not covered.
* Construction of models vary. Warranty applies only to components included with your specific appliance.

CONDITIONS AND LIMITATIONS

CAESAR FIREPLACE® warrants its products against manufacturing defects to the original purchaser only. Registering your warranty is not necessary.
CAESAR FIREPLACE® warrants its products against manufacturing defects to the original purchaser only. Registering your warranty is not necessary.
Simply provide your proof of purchase along with the model and serial number to make a warranty claim. CAESAR FIREPLACE® reserves the right to have its representative inspect any product or part thereof prior to honoring any warranty claim. Provided that the purchase was made through an authorized CAESAR FIREPLACE® dealer your appliance is subject to the following conditions and limitations:
Warranty coverage begins on the date of original installation.
This factory warranty is non-transferable and may not be extended whatsoever by any of our representatives.
Installation must be done in accordance with the installation instructions included with the product and all local and national building and fire codes.
This limited warranty does not cover damages caused by misuse, lack of maintenance, accident, alterations, abuse or neglect and parts installed from other manufacturers will nullify this warranty.
In the first year only, this warranty extends to the repair or replacement of warranted parts which are defective in material or workmanship provided that the product has been operated in accordance with the operation instructions and under normal conditions.
CAESAR FIREPLACE® will not be responsible for installation, labor or any other expenses related to the reinstallation of a warranted part and such expenses are not covered by this warranty. Notwithstanding any provisions contained in the Limited Warranty, CAESAR FIREPLACE®'s responsibility under this warranty is defined as above and it shall not in any event extend to any incidental, consequential or indirect damages.
This warranty defines the obligations and liability of CAESAR FIREPLACE® with respect to the CAESAR FIREPLACE® electric appliance and any other warranties expressed or implied with respect to this product, its components or accessories are excluded. CAESAR FIREPLACE® neither assumes, nor authorizes any third party to assume, on its behalf, any other liabilities with respect to the sale of this product.
Any damages to appliance, brass trim or other component due to water, weather damage, long periods of dampness, condensation, damaging chemicals or cleaners will not be the responsibility of CAESAR FIREPLACE®.
CAESAR FIREPLACE® reserves the right to have its representative inspect any product or part thereof prior to honoring any warranty claim.
All parts replaced under the Limited Warranty Policy are subject to a single claim.
All parts replaced under the warranty will be covered for a period of 90 days from the date of their installation.
Defects must be brought to the attention of Caesar Fireplace Technical Service by contacting Caesar Fireplace 1-800-306-3829, or 19295 E. Walnut Dr N, City of Industry, CA 91748. Please have proof of purchase, catalogue/model available when calling. Limited warranty service requires a proof of purchase of the product.
The manufacturer may require that defective parts or products be returned or that digital pictures be provided to support the claim. Returned products are to be shipped prepaid to the manufacturer for investigation. If a product is found to be defective, the manufacturer will repair or replace such defect.
Before shipping your appliance or defective components, your dealer must obtain an authorization number. Any merchandise shipped without authorization will be refused and returned to sender.
Shipping costs are not covered under this warranty.
Additional service fees may apply if you are seeking warranty service from a dealer.

ALL SPECIFICATIONS AND DESIGNS ARE SUBJECT TO CHANGE WITHOUT PRIOR NOTICE DUE TO ON-GOING PRODUCT IMPROVEMENTS.
CAESAR FIREPLACE® IS A REGISTERED TRADEMARK OF CAESAR HARDWARE INTERNATIONAL LIMITED.