

JASON[®]

HYDROTHERAPY

8328 MacArthur Dr. • North Little Rock, AR 72118
 501.771.4477 • Fax: 501.771.2333
 Customer Service: 800.255.5766
 www.jasoninternational.com

Designer Collection Specifications

AN553P

AirMasseur[®] -Soaking

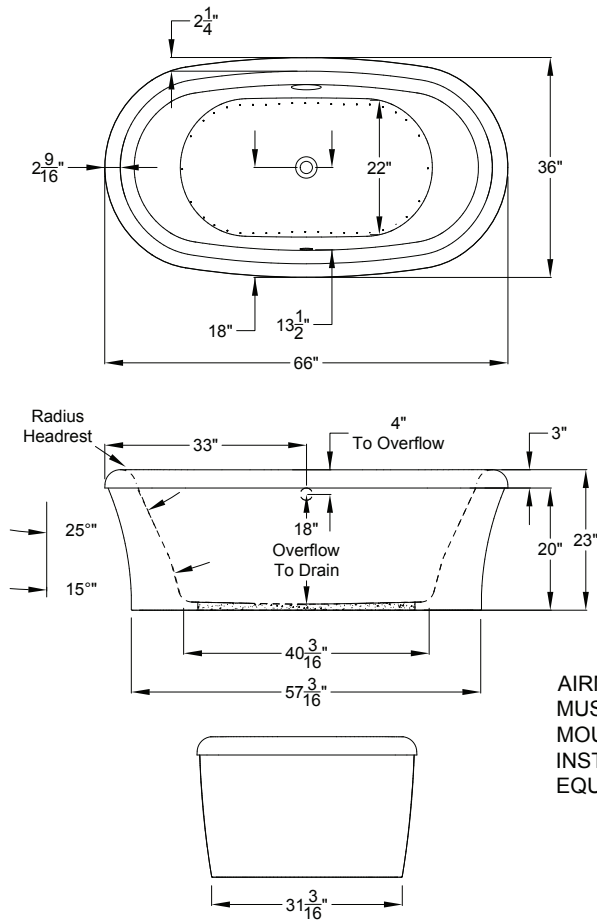

Shown with optional Ring Base

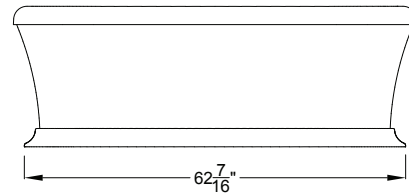
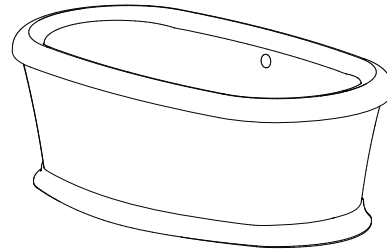

AIRMASSEUR BLOWER MUST BE REMOTE MOUNTED OR INSTALLED IN AN AEC EQUIPMENT CABINET.

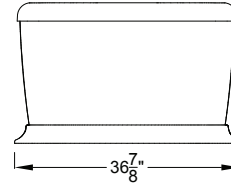



Patents recieved or pending.

Note: Dimensional Tolerances: ±1/4"

Drop-in-Hole Size:	N/A
Operating Capacity:	42 Gal.
Overflow Capacity:	70 Gal.
Floor Loading / sq.ft.:	57.1/53.9 lbs.
Carton Weight:	185/147 lbs.
Cube:	36.6 ft. ³

Construction: Fiberglass reinforced acrylic bath with Level Form™ full-support base.

We provide products listed with Intertek ETL SEMKO (Edison Testing Laboratories) U.S. and Canadian and with International Association of Plumbing and Mechanical Officials (IAPMO). Consult factory with your listing requirements.

Standard	 <p>A 120V system that includes a 1HP, variable speed air blower with integral air heater; automatic purge cycle; an electronic control that operates blower and blower speed for continuous, pulse or wave massage modes; and a 20-minute timer.</p>
Premier	 <p>A 120V system that includes a 1HP, variable speed air blower with integral air heater; (2) Chromatherapy mood lights; Automatic Ozone System; an electronic control that operates blower and blower speed for continuous, pulse or wave massage modes; automatic purge cycle; and a 20-minute timer. The keypad also operates the LED Chromatherapy mood lights.</p>
Signature	 <p>A 120V system that includes a 1HP, variable speed air blower with integral air heater; (2) Chromatherapy mood lights; Automatic Ozone System; a digital control with LCD display window; automatic purge cycle; and a 20-minute timer. Control keypad operates the blower and blower speed for continuous, pulse or wave massage modes, LED Chromatherapy mood lights and shows blower speed, water temperature and time remaining. Includes Bluetooth Sound Immersion.</p>

JASON[®]

HYDROTHERAPY

8328 MacArthur Dr. • North Little Rock, AR 72118
 501.771.4477 • Fax: 501.771.2333
 Customer Service: 800.255.5766
 www.jasoninternational.com

Designer Collection Specifications

AN553P

MicroSilk[®]

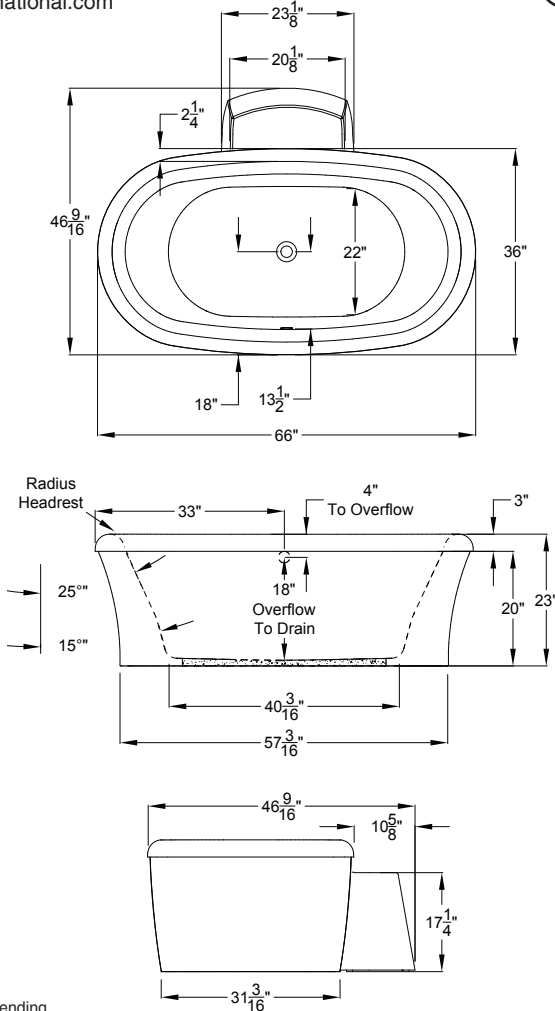

Shown with optional Ring Base

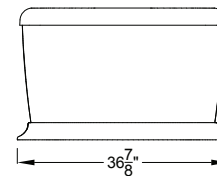
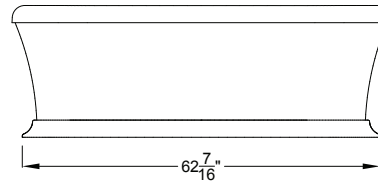
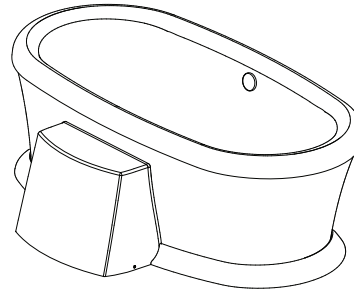

Patents received or pending.



Note: Dimensional Tolerances: ±1/4"

- Drop-in-Hole Size:** N/A
- Operating Capacity:** 42 Gal.
- Overflow Capacity:** 70 Gal.
- Floor Loading / sq.ft.:** 56.5 lbs.
- Carton Weight:** 178 lbs.
- Cube:** 36.6 ft.³

Note: Acrylic Equipment Cabinet is standard and required on MicroSilk[®] baths.

Construction: Fiberglass reinforced acrylic bath with Level Form[™] full-support base.

We provide products listed with Intertek ETL SEMKO (Edison Testing Laboratories) U.S. and Canadian and with International Association of Plumbing and Mechanical Officials (IAPMO). Consult factory with your listing requirements.

Standard	 <p>A 120V system that includes a MicroSilk unit; an electronic control; and a 20-minute timer.</p>
Premier	 <p>A 120V system that includes a MicroSilk unit; (2) Chromatherapy mood lights, Automatic Ozone System; an electronic control; and a 20-minute timer. The keypad also operates the LED Chromatherapy mood lights.</p>
Signature	 <p>A 120V system that includes a MicroSilk unit, (2) Chromatherapy mood lights; Automatic Ozone System; a digital control with LCD display window; low water and water temperature sensors; and a 20-minute timer. Control keypad operates the MicroSilk[®] unit, LED Chromatherapy mood lights and shows water temperature and time remaining. Includes Bluetooth Sound Immersion.</p>