

STEP 3

(Recommended for professional installers only.)

Attach the undermount clips. Position bowl so that reveal is equidistant.

Then on underside of countertop, drill holes for brass inserts of undermount clips.

Use a drill bit with stop block to avoid drilling through the top. For 1/2" countertop material, drill 3/8" deep holes. Use three clips on the long sides of the sink, and two clips on the short sides of the sink, or follow the Locations on the template that comes with the sink. Drill the holes 1" back from the cutout edge.

NOTE:

The undermount clip is 3/4" wide and 2-3/4" in length. The clip may be too long for some installations. If this is the case, make a brace out of wood or solid surfacing, butt it up against the sink, and, on site, screw it into the cabinet wall.

Measure the thickness of the brace and the cabinet wall so the screw does not go through to the other side of the cabinet. Instructions continued on back panel.

STEP 4

(Recommended for professional installers only.)

Install the sink. Clean the bottom of the countertop and the top flange (or lip) of the sink with denatured alcohol. Then apply a bead of silicone adhesive sealant to the top edge of the bowl flange and position the bowl in the countertop.

STEP 5

(Recommended for professional installers only.)

Tighten the clips. Tap in the brass inserts (anchors) for clips into the pre-drilled holes with the slotted ends first. Thread a wing nut onto a screw, up near the head.

With washer and slotted clip in place,

Tighten the screw to anchor the brass clip into the countertop material.

Repeat for each clip. Hand-tighten the wing nut to secure the sink bowl.

NOTE:

Do not fully tighten one clip at a time. Partially tighten a clip, then partially tighten the clip across from it. After each clip is partially tightened, repeat the process, fully tightening each clip. This ensures a secure installation and avoids damage to the sink.

NOTE FOR MARBLE OR GRANITE:

Use lead anchors which are glued in, rather than brass undermount clips.

Remove excess sealant from the inside lip of the bowl using appropriate cleaner on a clean rag.

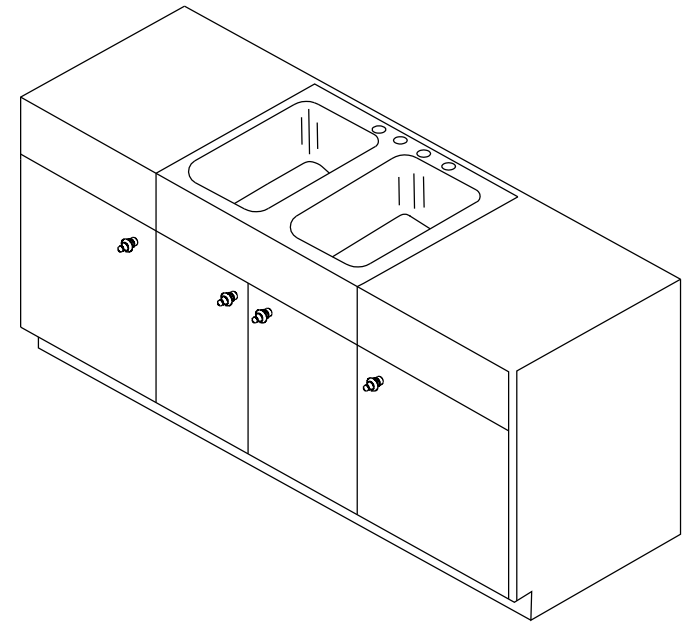

www.kingstonbrass.com

TOLL-FREE CUSTOMER SERVICE: 1-877-2-KBRASS

TECHNICAL SUPPORT E-mail: service@kingstonbrass.com

12775 Reservoir Street, Chino, CA 91710



KINGSTON BRASS INSTALLATION INSTRUCTIONS UNDERMOUNT SINKS

These instructions are for installing Kingston Brass Undermount stainless steel sinks. Undermount sinks are sinks that are mounted from below the countertop. If you are installing another type of sink, such as a Drop-In sink which is installed on top of the counter, please refer to instructions specifically for those sinks. Kingston Brass Undermount sinks can be installed with three different reveals - Positive, Zero, or Negative - each Creating a distinctive look where the countertop and sink meet (see diagram). Deciding on your preferred Look must be done prior to installation.

Positive Reveal - The countertop edge sits approximately 1/8" back from the edge of the sink, exposing the sink rim. All Kingston Brass undermount sinks feature a 1" finished rim. All Kingston Brass undermount sinks feature an approximate 1/8" positive reveal.

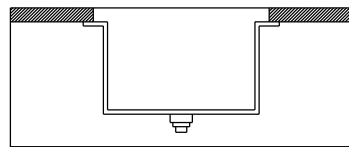

Zero Reveal - The countertop meets the edge of the sink, fitting flush with the sink bowls.

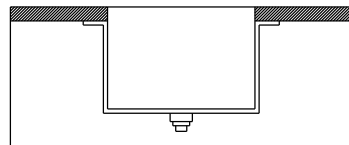

Negative Reveal - The countertop extends over the edge of the sink on all sides by approximately 1/8". Use caution with this installation to be sure that accessories such as Colanders or cutting boards will fit properly.

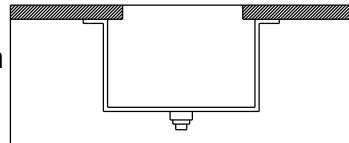

Templates are supplied only as a guide. The physical use of the sink will ensure a more accurate cutout.

The instructions that follow are for installing a Kingston Brass undermount stainless steel sink in a solid surface countertop only. Minimum thickness of the actual countertop material is one half-inch. In addition, a one-inch build up around the sink is preferred. Kingston Brass recommends that undermount sinks and routing of your solid surface material should be installed by a professional installer for best results.

Requirements vary for installation in a granite, marble, stone, or butcher block countertop. Please contact your fabricator for specific details. Before installing, inspect the sink for damage. Do not install a damaged unit. Remember, it is your responsibility to follow all local plumbing and building codes. The warranty will be voided if these installation instructions are not followed.

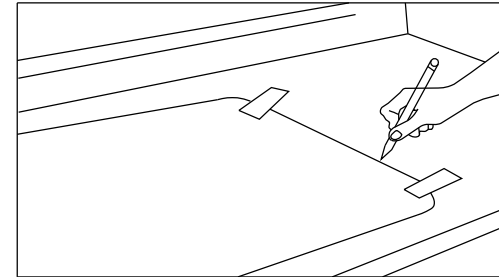

STEP 1

(Recommended for professional Installers only.)

Create a template. Using a framing square, draw a line from front to back on the bottom of the countertop, indicating the location of the center of the sink. Draw a line parallel to the front edge of the countertop, indicating how far back the sink should be located. Typically the setback is 2" to 2-1/2" from the front of the counter, depending on the countertop overhang, the type of sink bowl and the size of the sink deck. To create a template, turn the sink upside down on the piece of plywood and draw around it. Or place template transfer paper or cardboard template on plywood.

NOTE:

Paper and cardboard templates are supplied only as a guide. Using the actual sink ensures a more accurate cutout. Mark the centerpoint of the sink on the template.

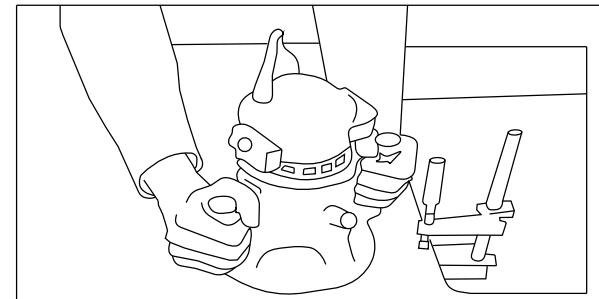

STEP 2

(Recommended for professional installers only.)

Make the sink cutout. Find the center of the sink template and align it with the center mark drawn on the countertop. Place the template with the front edge along the front edge line drawn on the countertop. Secure the plywood template to the countertop using 6" bar clamps. Place the router over the plywood template and cut around it, making sure the router follows the edge of the template. This creates the sink cutout. Finish the inside of the sink cutout according to the recommendations of the countertop material supplier.

Installation Instructions For Use With KB's Basket Strainer

NOTE: USE TEFLON TAPE ON ALL THREADED CONNECTIONS

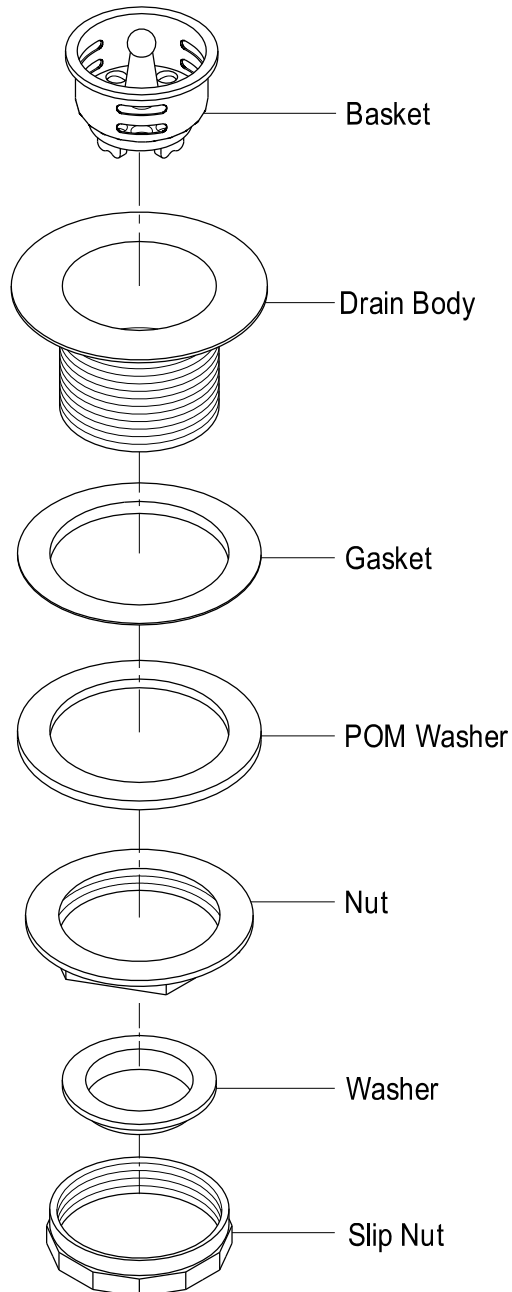

www.kingstonbrass.com

TOLL-FREE CUSTOMER SERVICE: 1-877-2-KBRASS

TECHNICAL SUPPORT E-mail: service@kingstonbrass.com

12775 Reservoir Street, Chino, CA91710