

SPECIFICATIONS

Features/Benefits

- SnapBack[®] Retraction System
- Easily Adjustable GripLock[®] Weight
- 1.75 gpm (6.6 L/min) Max Flow @ 60 psi
- 2 Function Spray/Aerated Stream
- Ceramic Disc Cartridge
- 14 5/8" Spout Height, 8 5/8" Spout Reach
- 360 Degree Swivel Spout
- Single Hole Installation
- Optional Deck Plate, DA667229 (4") or DA665051 (8"), Sold Separately for 3-Hole Applications



Available Color/Finishes

Color	Description
-------	-------------

 Chrome

Please see danze.com or current price list for available finishes. Finish is defined by additional suffix.

Standards & Certifications

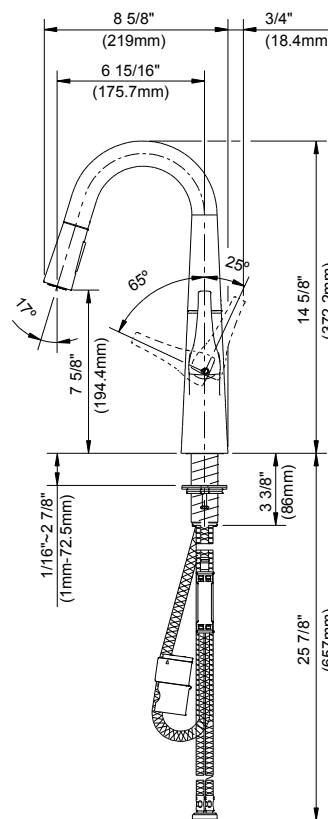
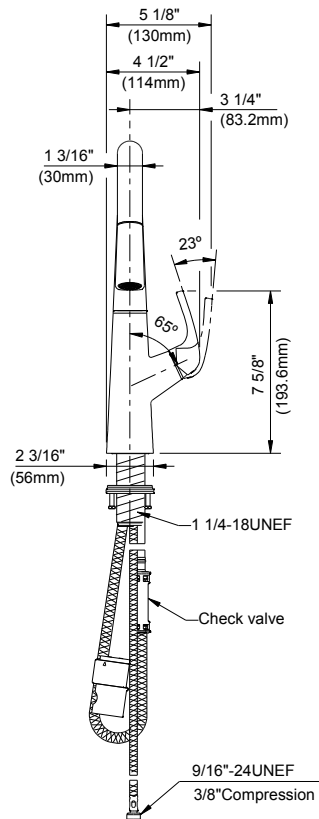

Submittal Information:

Name: _____
Location: _____

Contractor: _____
Contact #: _____