

RESORT BASIN

Cat. No.
4-1080WH



Width: $22\frac{7}{8}$ "
Depth: $14\frac{1}{2}$ "
Above Counter Height: $5\frac{1}{2}$ "

Features:

- ▶ Vitreous China
- ▶ No faucet holes
- ▶ No overflow
- ▶ Template included
- ▶ Hardware not included
- ▶ Use with Umbrella drain #UD701

Colors:

WH White

Compliance Certification

Meets or exceeds the following specifications: ASME A112.19.2 2013 and CSA B45.1-13 for plumbing fixtures.

***Please do NOT drill hole without template or actual product.**

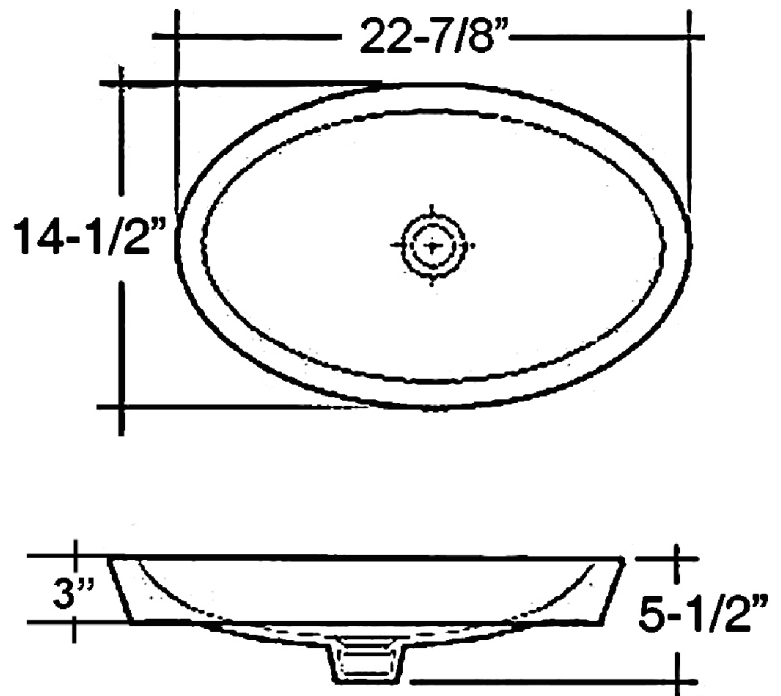

Interior Dimensions:

Basin interior: $20\frac{1}{2}$ " X $12\frac{1}{4}$ "
Basin depth: $3\frac{1}{2}$ "

Dimensions of fixture are nominal and may vary within the range of tolerances established by ANSI Standard A112.19.2. Dimensions and specifications subject to change without notice.