

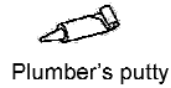

Single Handle Lavatory Faucet LFS300

INSTALLATION INSTRUCTIONS

Tools You Will Need:



Plumber's putty



Pipe tape

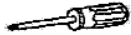

Philips Screwdriver



Pliers



Adjustable wrench



Lavatory Faucet Installation

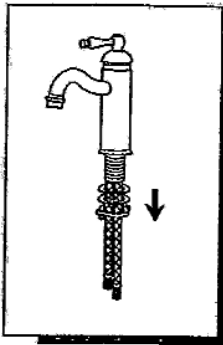

1. Remove the mounting hardware from the faucet.

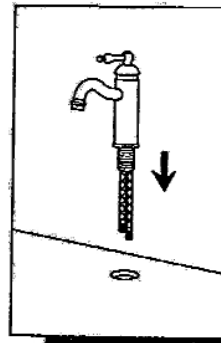

2. Install faucet body through top of sink.

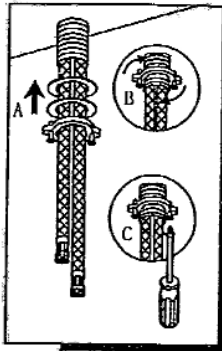

3. From underneath the sink, replace the washers and lock nut. Use philips screwdriver for final tightening after spout is aligned.

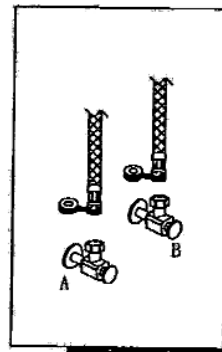

4. Connect to water supply.

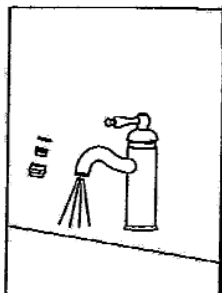

5. After installing faucet, remove spray assembly and open the hot and cold water supplies. Check for leaks. Turn on faucet handle for one minute to flush debris from faucet. Close the handles and re-assemble the spray.



Single Handle Lavatory Faucet LFS300

Exploded Drawing:

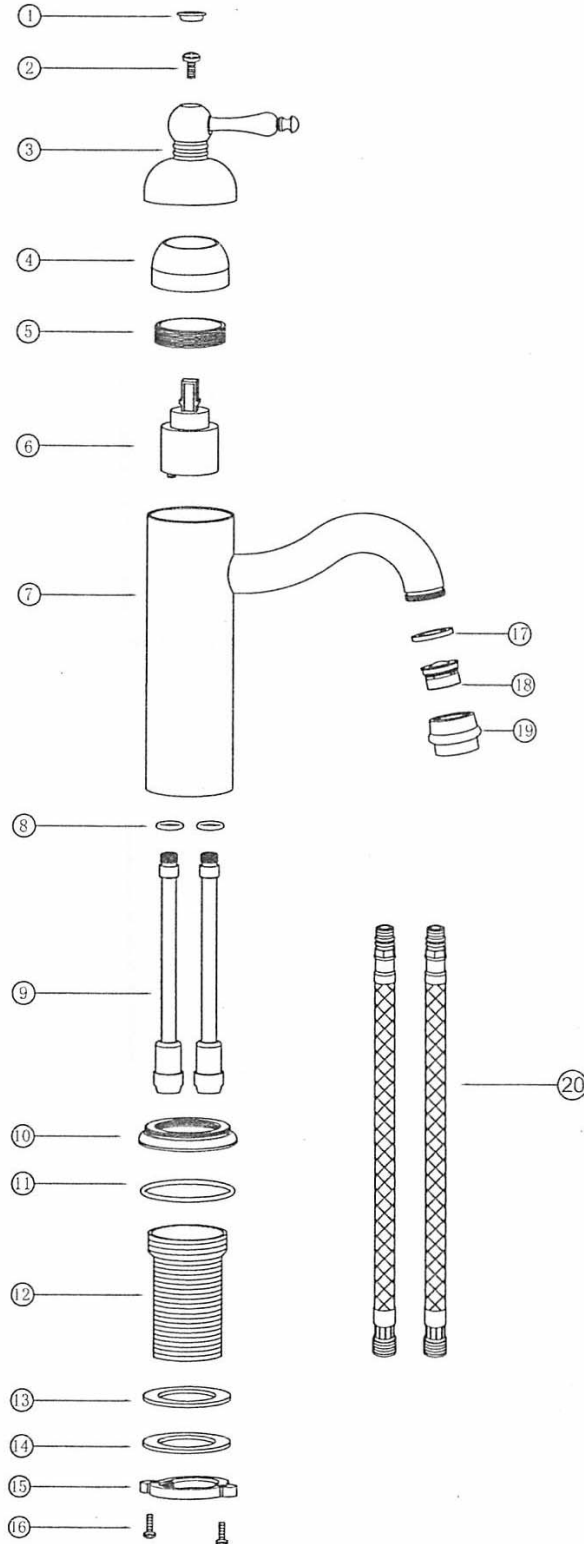

No.	Part Description	Quantity
20	Braided Hose	2
19	Aerator Cover	1
18	Aerator	1
17	Gasket	1
16	Screw	2
15	Locknut	1
14	Metal Washer	1
13	Washer	1
12	Connector Pipe	1
11	O-ring	1
10	Trim Ring	1
9	Copper Tube	2
8	O-ring	2
7	Body	1
6	Ceramic Disk Cartridge	1
5	Retainer Nut	1
4	Trim Cap	1
3	Handle	1
2	Screw	1
1	Button	1