



ENGLISH

SMARTCODE 913

TOUCHPAD ELECTRONIC DEADBOLT

Installation and User Guide

Required tools

4 AA Batteries Ruler Phillips head screwdriver

Additional Tools (depending on application)

Hammer Wood block

Kwikset
1-800-327-5625
www.kwikset.com

Parts in the box

Latch	Interior Assembly		Exterior Assembly	
	<i>Traditional</i> 	<i>Contemporary</i> 	<i>Traditional</i> 	<i>Contemporary</i>
	B is not included. If needed, please contact Kwikset to order a drive-in latch for your lock.			
Strike	Keys			Fasteners
				03809
Adapter Ring	Mounting Plate	SmartKey Tool	48654 	46780
			49191 	64109

1 Prepare the door and check dimensions

If drilling a new door, use the supplied template and the complete door drilling instructions available at www.kwikset.com/doorprep.

<p>A Measure to confirm that the hole in the door is either 2-1/8" (54 mm) or 1-1/2" (38 mm).</p>	<p>B Measure to confirm that the backset is either 2-3/8" or 2-3/4" (60 or 70 mm).</p>	<p>C Measure to confirm that the hole in the door edge is 1" (25 mm).</p>	<p>D Measure to confirm that the door is between 1-3/8" and 2" (35 mm and 51 mm) thick.</p>
--	---	--	--

Note: Additional door preparation may be required for doors with 1-1/2" (38 mm) holes. Consult the deadbolt drilling instructions at www.kwikset.com/doorprep.

2 Install the latch and strike

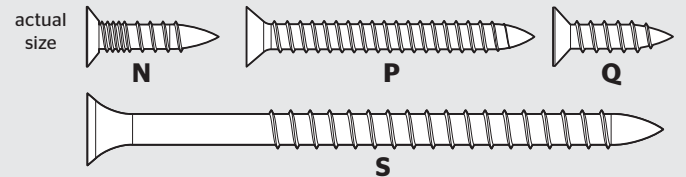

<p>A Is the door edge chiseled?</p> <div style="display: flex; justify-content: space-around;"> <div style="text-align: center;"> <p>YES</p> <p>Use latch "A". If the latch bolt is not already extended, extend the latch bolt as shown.</p> </div> <div style="text-align: center;"> <p>NO</p> <p>Use latch "B" (not included). If the latch bolt is not already extended, extend the latch bolt as shown.</p> </div> </div>	<p>B Hold the latch in front of the door hole, with the latch face flush against the door edge.</p>	<p>D Which latch are you installing?</p> <div style="display: flex; justify-content: space-around;"> <div style="text-align: center;"> <p>Latch "A"</p> <p>N or P (2x)</p> </div> <div style="text-align: center;"> <p>Latch "B"</p> <p>wood block</p> </div> </div>
<p>C Is the D-shaped hole centered in the door hole?</p> <div style="display: flex; justify-content: space-around;"> <div style="text-align: center;"> <p>YES</p> <p>No adjustment is required. Proceed to next step.</p> </div> <div style="text-align: center;"> <p>NO</p> <p>Rotate latch face as shown to extend latch.</p> </div> </div>		<p>E Install strike on the door frame.</p> <p>⚠ Make sure the hole in the door frame is drilled a minimum of 1" (25 mm) deep.</p> <p>Longer screws install closest to the door jamb.</p> <p>S (2x) Q (2x) door frame</p>

3 Install the exterior keypad

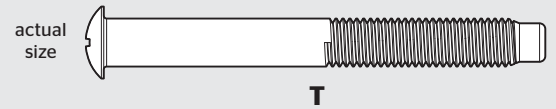

A What is the diameter of the hole in the door?

<p>Diameter is 2-1/8" (54 mm)</p> <p>"D" is required for installation. Install "D" on "F".</p>	<p>or</p>	<p>Diameter is 1-1/2" (38 mm)</p> <p>"D" is not needed for installation. Discard "D".</p>
---	-----------	--

B Locate screws for step 3C and keep them within reach.

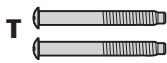

C Install exterior keypad and mounting plate.

<p>a</p> <p>Cable goes underneath latch.</p>	<p>b</p> <p>Support exterior assembly during mounting plate installation.</p> <p>Route cable through center hole, then push cable into bottom hole.</p>
<p>c</p> <p>Keep parallel to edge of door.</p> <p>Tighten T (2x) screws evenly.</p>	<p>d</p> <p>Insert key and test latch. If latch does not extend or retract smoothly, adjust screws (T).</p> <p>Remove key when finished and make sure the latch bolt is fully extended.</p>

4 Install the interior assembly

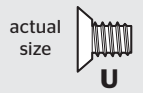

A Remove battery cover and battery pack from interior assembly.

<p>a</p> <p>Make sure turnpiece is in the vertical position.</p>	<p>b</p>
<p>c</p> <p>Make sure turnpiece shaft is rotated as shown.</p>	<p>d</p> <p>Do not install batteries until step 5.</p>

B Install interior assembly onto mounting plate.

<p>a</p> <p>align</p> <p>Ensure tight cable connection.</p>	<p>b</p> <p>Lay excess cable flat inside the bottom of the interior housing.</p>
<p>c</p>	<p>d</p> <p>U (2x) bottom hole</p>

5 Install the batteries and perform the door handing process

This step will teach your lock the orientation of your door and is crucial to lock operation.

A Install 4 AA batteries in battery pack.

K

Ensure correct polarity. For best results, use new, non-rechargeable Alkaline batteries only.

B Press and HOLD the Lock button while installing battery pack. Hold button until the latch bolt starts moving on its own.

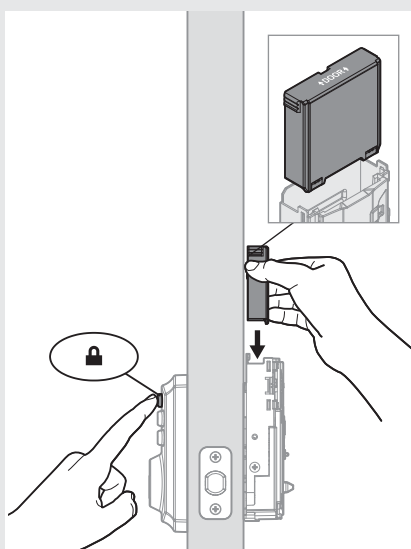

C Did the latch bolt retract and extend on its own when the battery pack was installed?

<p>YES</p> <p>Door handing process was successful! Proceed to next step after latch bolt stops moving.</p>	<p>OR</p>	<p>NO</p> <p>Note: Latch bolt will only retract half way.</p> <p>Remove battery pack, wait 15 seconds, then attempt the process again.</p>
---	-----------	---

6 Add user codes (16 max)

Programming Timeout

During programming, if no button is pressed for five seconds, the system will time out (indicated by three beeps and a red flashing keypad), and you will need to restart the procedure.

A Make sure the door is open. Press the Program button once.

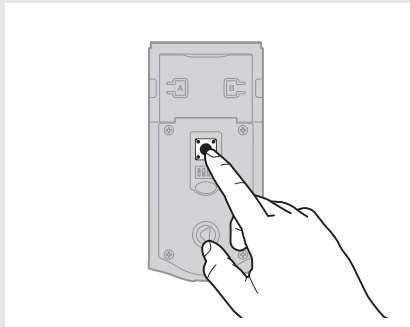

B Enter user code. A total of 16 user codes may be programmed.

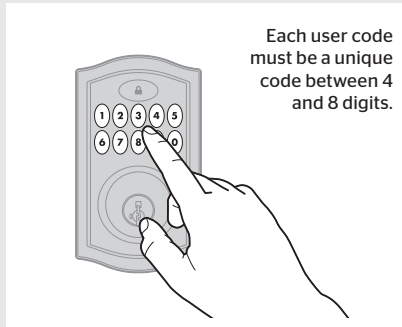

C Press Lock button once.

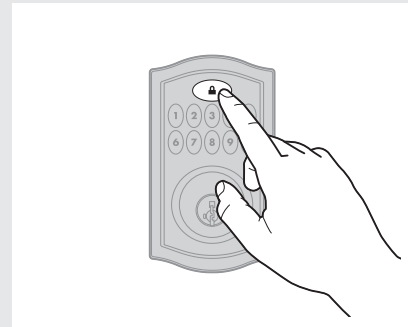

D What lights and sounds does the lock produce?

One green flash with one beep

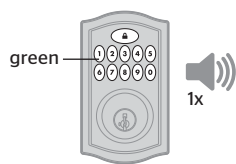

Programming was successful.

or

Three red flashes with three beeps

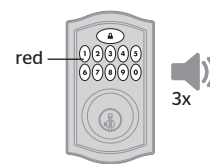

Programming was unsuccessful.

Make sure not to pause for more than 5 seconds during programming. Make sure the user code is not a duplicate and that it is between 4 and 8 digits during your next attempt. Make sure the lock has room for an additional code. If all user code positions are filled, delete a code to make room for this one.

*Beeping sound will only be heard if switch #3 (on the lock interior) is in the on position. See "Switches and Status LED Colors" on page 4.

Mastercode

For enhanced security, a mastercode may be used when adding and deleting user codes. For more information about the mastercode, download the Programming and Troubleshooting Guide on the SmartCode 913 page at www.kwikset.com.

7 Test the lock (review normal operation)

Confirm that the code(s) added in previous step can unlock the door.

Locking the Door

Press Lock button once.

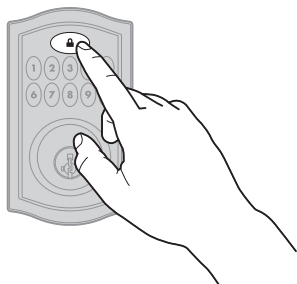

Unlocking the Door

Enter user code.

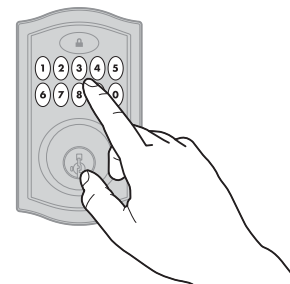

8 Re-key the lock (if needed) and install the battery cover

actual size 

A Re-key the lock (if needed).

a

IMPORTANT: Remove battery pack before re-keying.

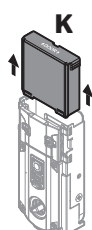

b

Re-key the lock to work with your existing key. See the supplied SmartKey Re-key instructions for more information.



c

Reinstall battery pack.

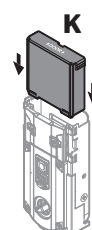

B Install the battery cover.

a

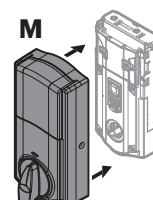

b

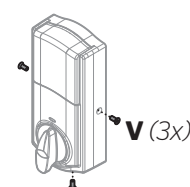

SmartCode at a Glance

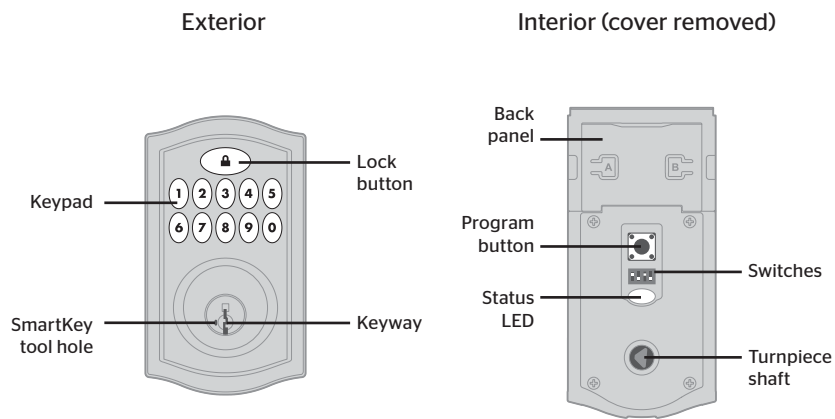

Note: When the cover is removed, the turnpiece shaft can be used to manually lock and unlock the door.

System Alerts

Alert	Reason	Solution
Keypad flashes red three times with three beeps*	One incorrect code entered.	Re-enter code.
	No user code programmed.	Program at least one user code.
	Programming timeout after five seconds. Unsuccessful programming.	Attempt programming procedure again.
Keypad flashes red 15 times with 15 beeps*	Three incorrect codes entered within one minute.	Re-enter code after 60 second keypad lockout.
Keypad flashes red with fast beeping sound for three to four seconds.	Low battery.	Replace batteries.
Keypad flashes green with continuous beeping sound for two seconds.	Door jammed while attempting to lock.	Manually re-lock door. If needed, reposition strike.

*Beeping sound will only be heard if switch #3 is on.

Switches and Status LED colors

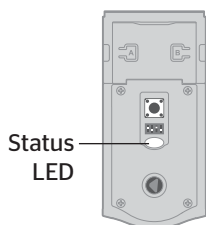
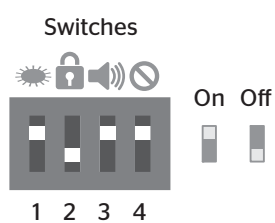

Switch	Function
1	Door lock status LED blinks every 6 seconds
2	Lock automatically re-locks door 30 seconds after unlocking. Disabled if no codes are programmed.
3	Audio
4	Not used.

Color	Lock Status
Blinking green	Unlocked
Blinking amber	Locked
Blinking red	Low battery
Solid red	Door handing process did not work properly. See the online Programming and Troubleshooting Guide.

Troubleshooting

A complete Programming and Troubleshooting Guide is available on the SmartCode 913 page at www.kwikset.com.

Deleting a single user code

Note: All codes may be deleted at once if the mastercode is enabled. For more information about the mastercode, consult the online Programming and Troubleshooting Guide.

1 Keep door open. Press Program button once.	2 Press Lock button once.	3 Enter user code to be deleted.	4 Press Lock button once.
5 Re-enter user code.	6 Press Lock button once.	If unsuccessful Make sure to enter the same valid code in steps 3 and 5.	⚠ Test code While the door is open, test the user code to make sure it no longer unlocks the door.

If no button is pressed for five seconds, the system will time out, and you will need to restart the procedure.

Factory Reset

A factory reset will delete all codes associated with the lock.

1 Remove battery pack.	2 Press and HOLD the Program button while reinserting the battery pack. Keep holding the button for 30 seconds until the lock beeps and the status LED flashes red.
3 Press the Program button once more. In 20 seconds, when the LED flashes green and you hear one beep, the lock has been reset.	4 Perform the door handing process again to teach the lock the orientation of the door and add user codes to your lock.

Important Safeguards

1. Read all instructions in their entirety.
2. Familiarize yourself with all warning and caution statements.
3. Remind all family members of safety precautions.
4. Protect your user codes and mastercode.
5. Dispose of used batteries according to local laws and regulations.

⚠ CAUTION: Prevent unauthorized entry. Since anyone with access to the back panel can change the user codes, you must restrict access to the back panel and routinely check the user codes to ensure they have not been altered without your knowledge. The use of a mastercode can help protect your system's settings.

⚠ WARNING: This Manufacturer advises that no lock can provide complete security by itself. This lock may be defeated by forcible or technical means, or evaded by entry elsewhere on the property. No lock can substitute for caution, awareness of your environment, and common sense. Builder's hardware is available in multiple performance grades to suit the application. In order to enhance security and reduce risk, you should consult a qualified locksmith or other security professional.