

SPECIFICATIONS

Features/Benefits

- 2.0 gpm (7.6 L/min) Maximum Flow Rate @80psi
- Includes Treysta™ Pressure Balance Ceramic Disc Cartridge
- Requires Treysta™ Rough-In Valve, G00GS500 Series (Horizontal Inputs) or G00GS520 Series (Vertical Inputs)
- Diverter on Tub Spout
- Includes Single-Function Mono Round Showerhead, D460053
- 6" Metal Shower Arm
- Accommodates Standard, Back-to-Back, and Thin Wall Installations



Available Color/Finishes

Color	Description
-------	-------------

 Chrome
Please see danze.com or current price list for available finishes.
Finish is defined by additional suffix.

Standards & Certifications



Flow Rate

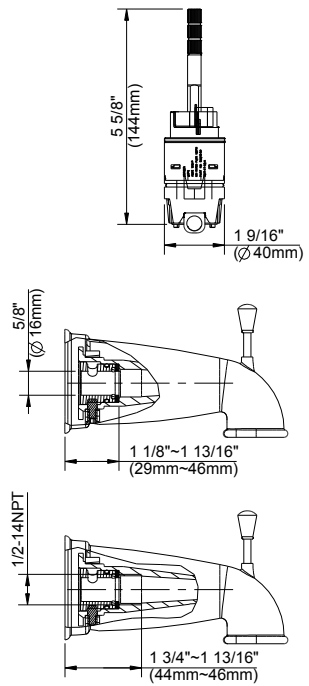
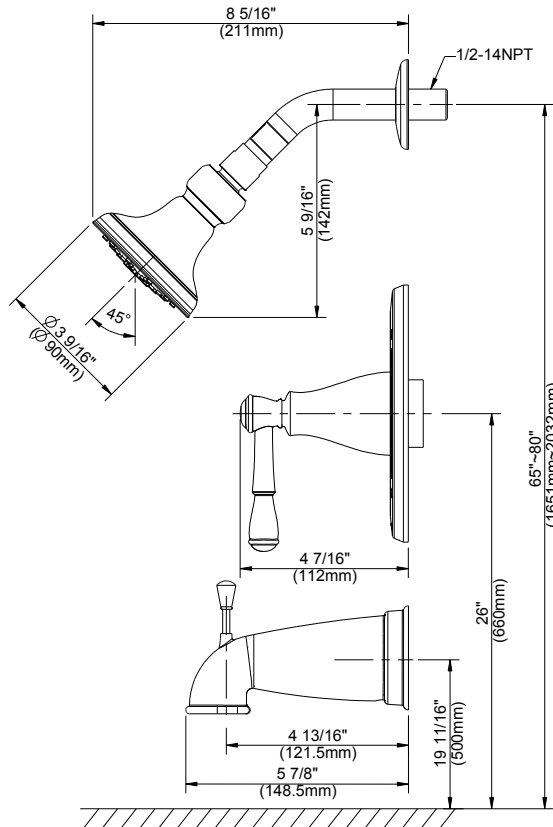
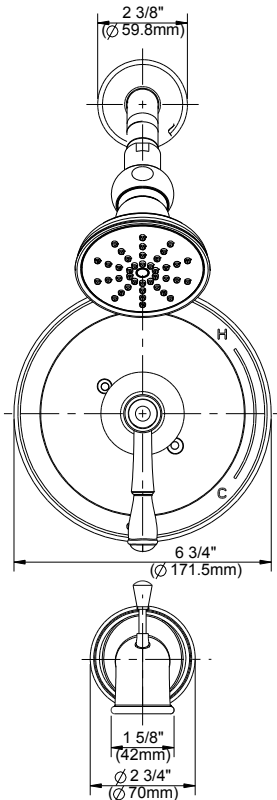
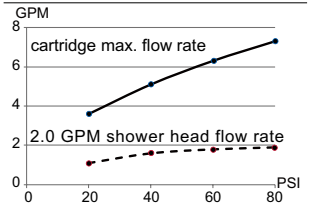

Submittal Information:

Name: _____
Location: _____

Contractor: _____
Contact #: _____