



FORMOSA

INSTALLATION GUIDE

FVN3130ACA-FS

CONTENTS:

Mirror	FMR3126ACA	PAGE 2
Cabinet	FCB3130ACA	PAGE 3
Sink	FCT2030WH-CMB	PAGE 3

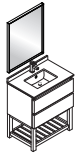

FVN3130ACA-FS FORMOSA INSTALLATION GUIDE



FVN3130ACA-FS
Vanity Front

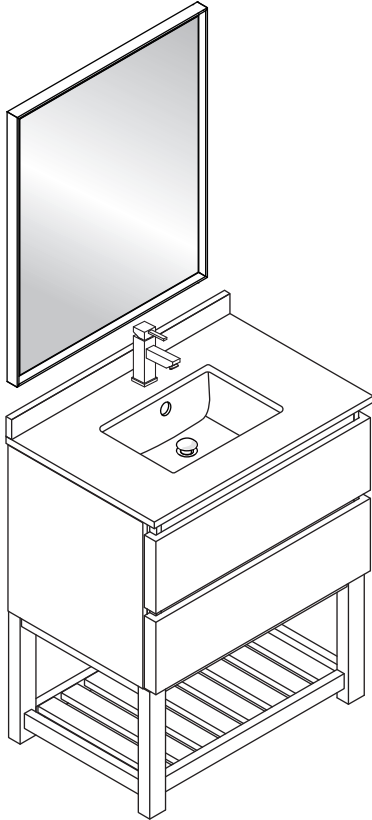

FMR3126ACA
Mirror Front

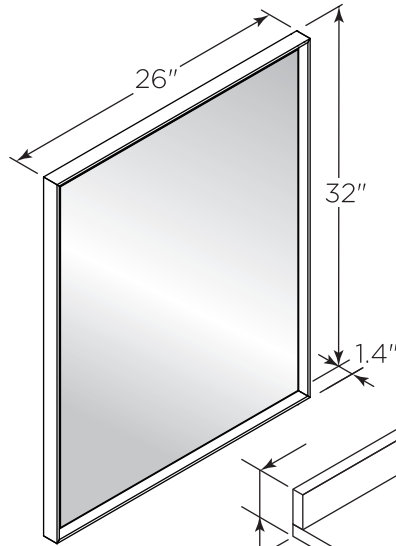

FCT2030WH-CMB
Counter Top Front

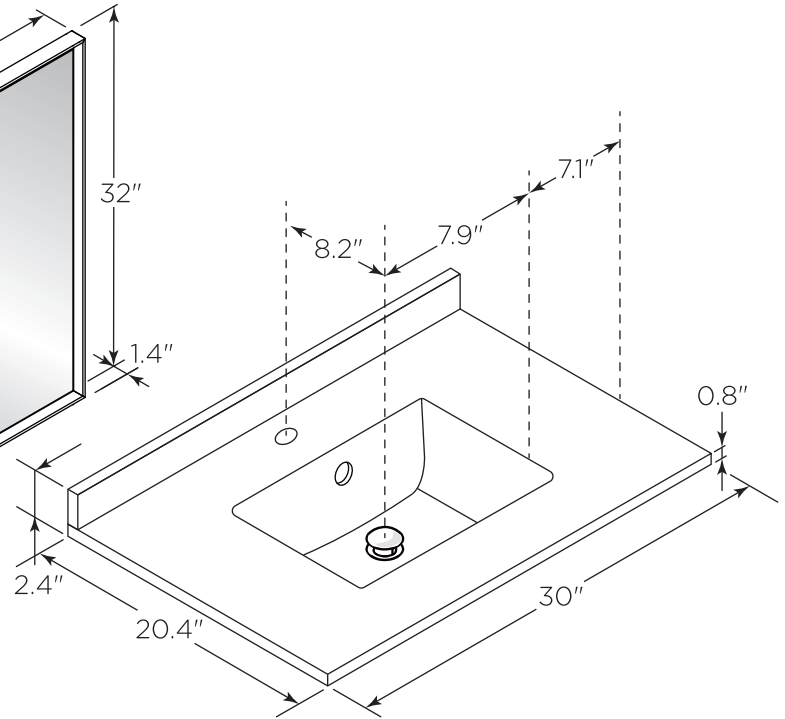

FCB3130ACA
Cabinet Front

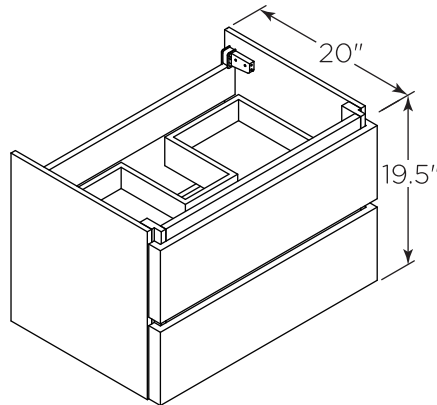

FCB3130ACA
Cabinet Back

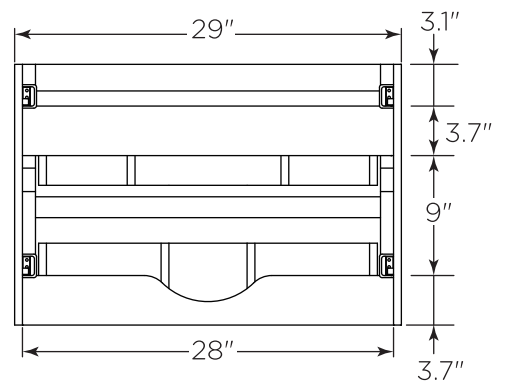

FSF3130ACA
Cabinet Front

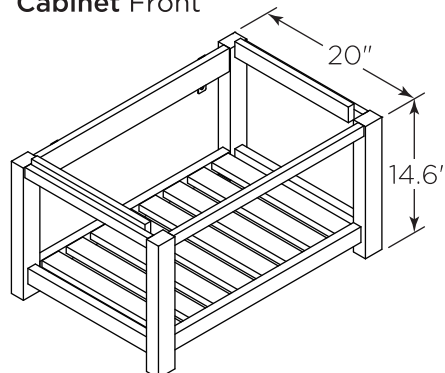

FSF3130ACA
Cabinet Back

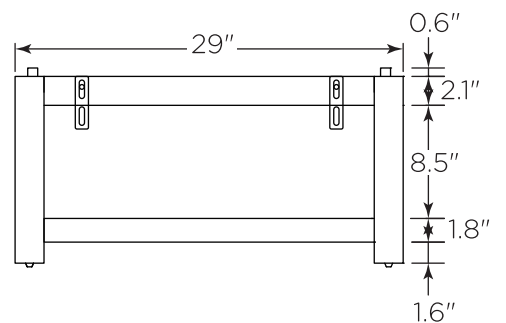

NOTE: All dimensions & specifications are approximate and subject to change without notice.

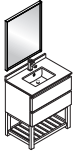

FVN3130ACA-FS FORMOSA INSTALLATION GUIDE



TOOLS FOR ASSEMBLY

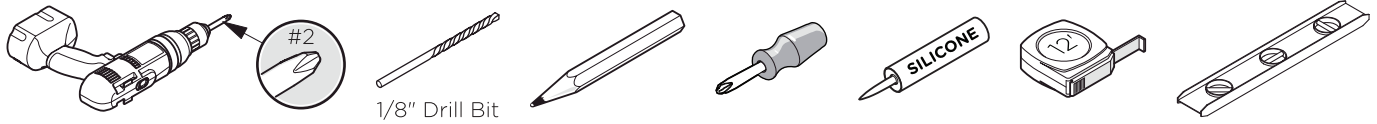

MIRROR INSTALLATION

- 1** Measure distance between the holes and mark it on the wall using a level.

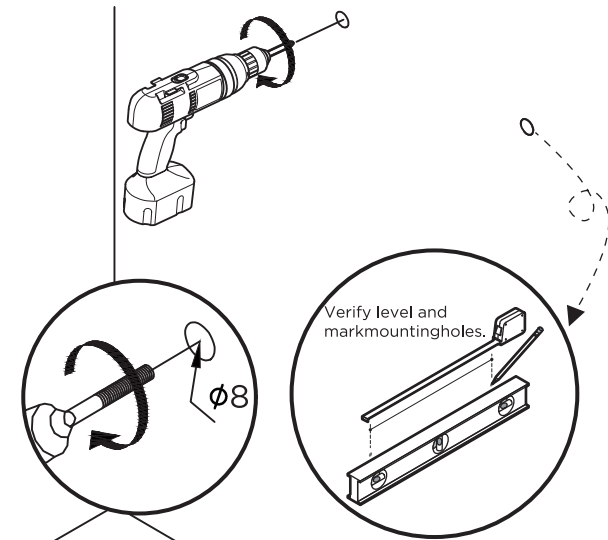

- 2** Press the anchors into the holes.

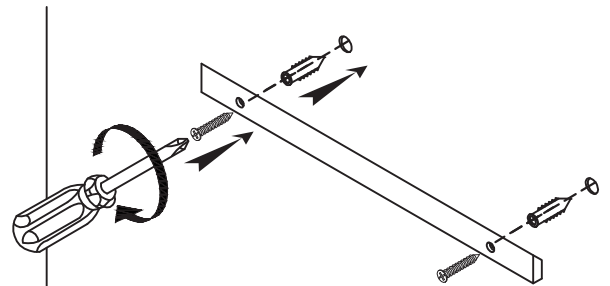

IMPORTANT: Consult an expert for the proper screws/bolts to use when attaching to various constructions. Screws provided do not attach to all wall construction types. Anchors are not required if brackets are installed in stud.

- 3** Hang mirror on the screws.

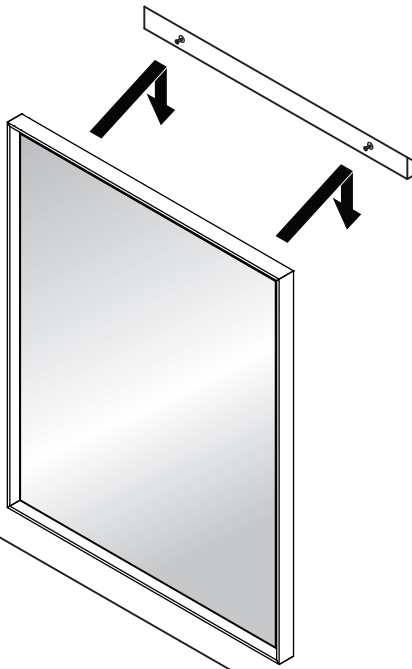

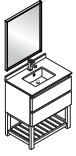

CABINET & SINK INSTALLATION

1 Connect cabinet (A) to cabinet (B) with iron sheet.

IMPORTANT: Consult an expert for the proper screws/bolts to use when attaching to various constructions, Screws provided do not attach to all wall construction types. Anchors are not required if brackets are installed in stud.

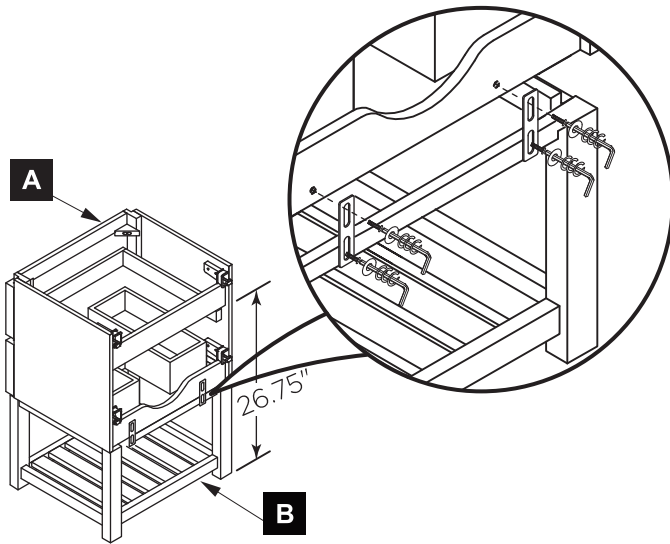

2 Mark anchor mounting hole locations on wall as shown. Drill holes in the finished wall as required. Then insert the anchor(1) into the holes and secure the wall bracket(2) with the screws(3).

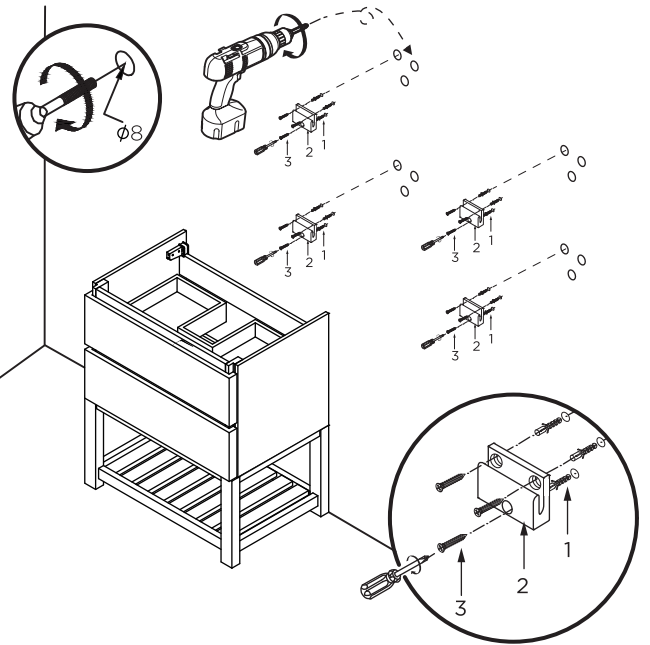

3 Install sink.

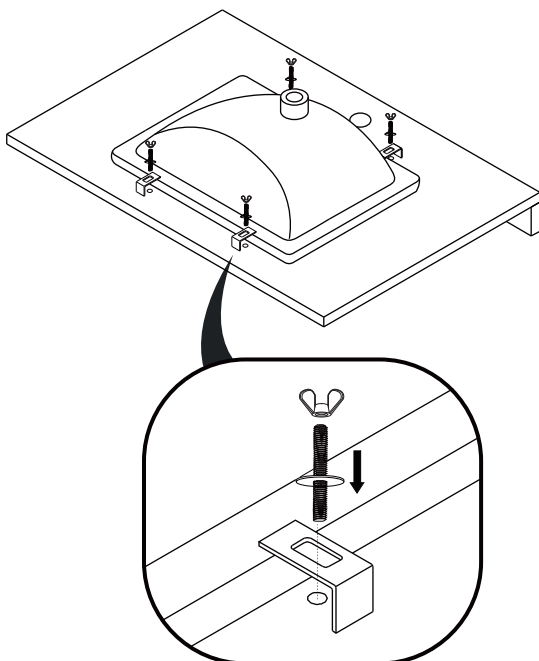

4 Apply a bead of silicone on the top of the cabinet (C) and place sink (D) on the cabinet.

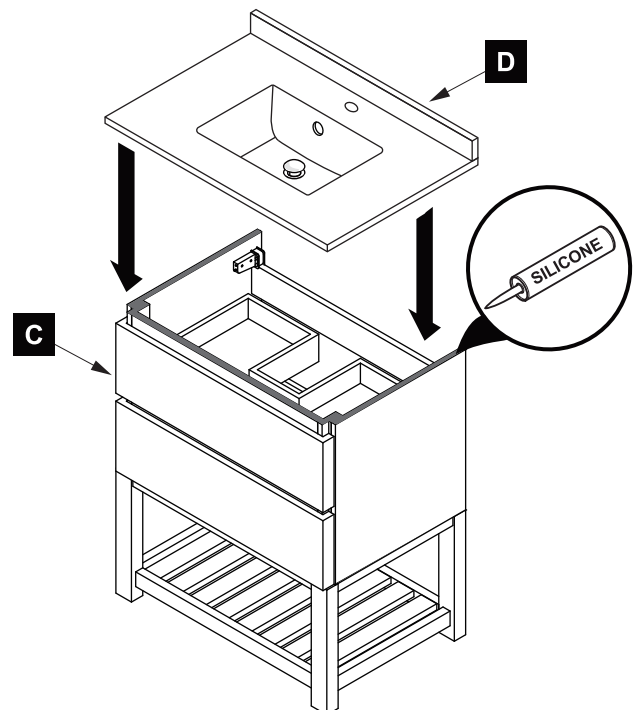

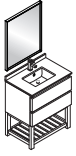

DRAWER REMOVAL & INSTALLATION

REMOVAL

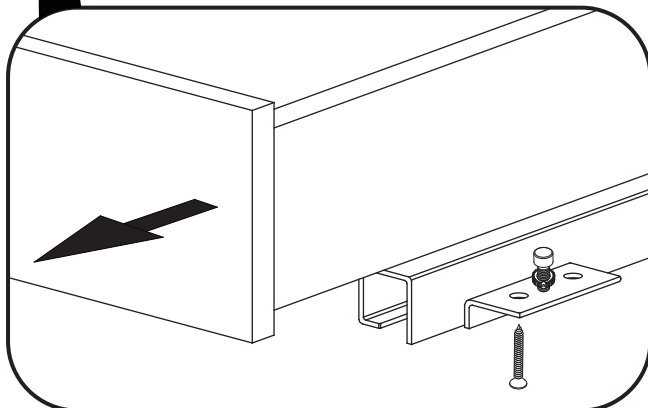
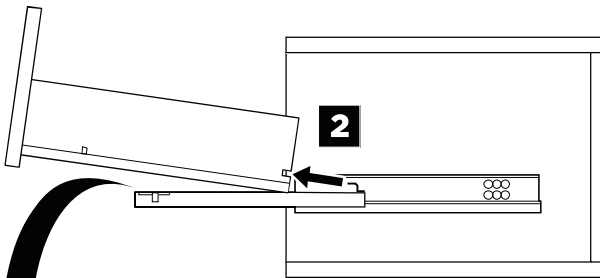
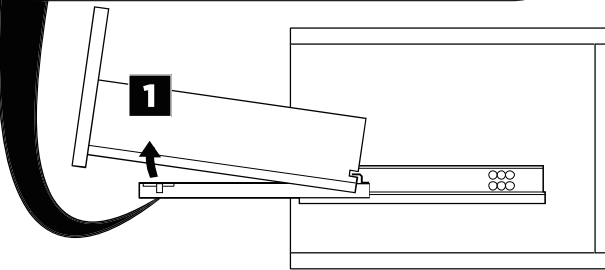
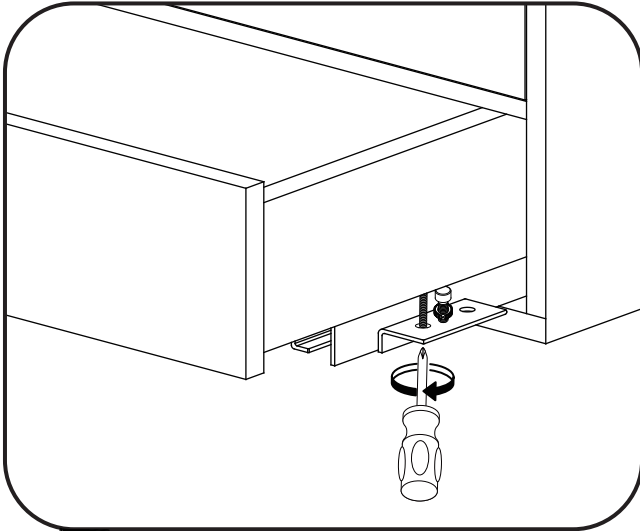

INSTALLATION

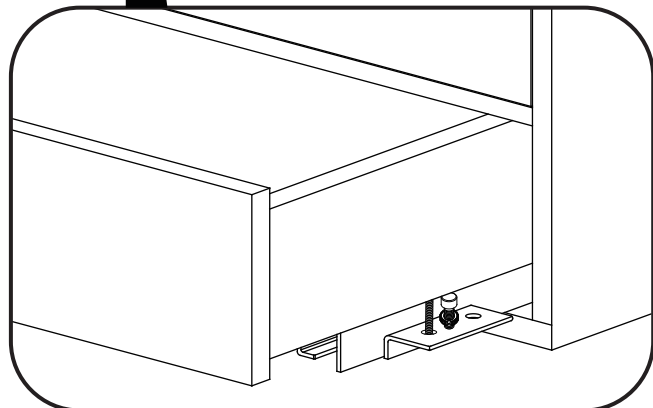
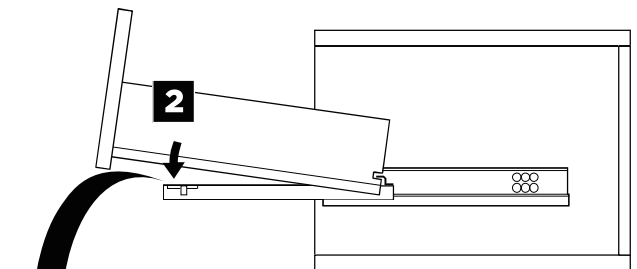
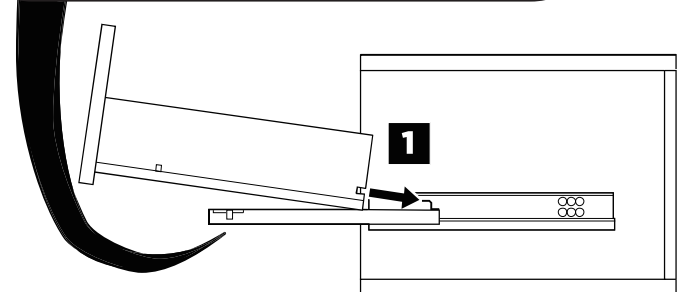
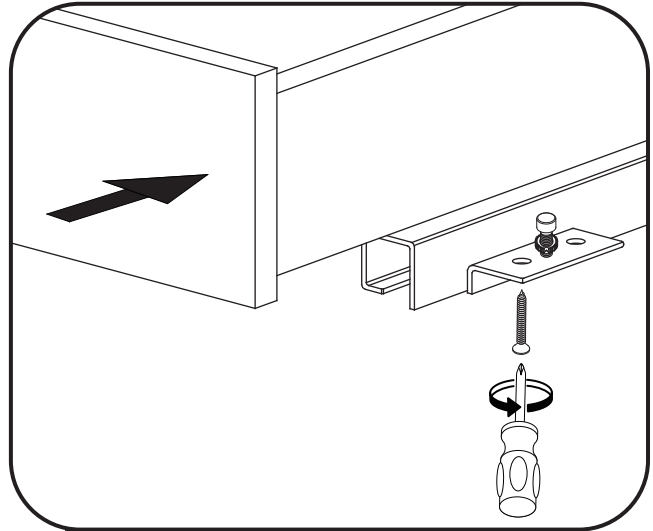

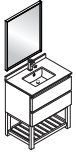

P-TRAP AND POP-UP INSTALLATION INSTRUCTIONS

NOTE:
 Your item may appear slightly different from the illustration.

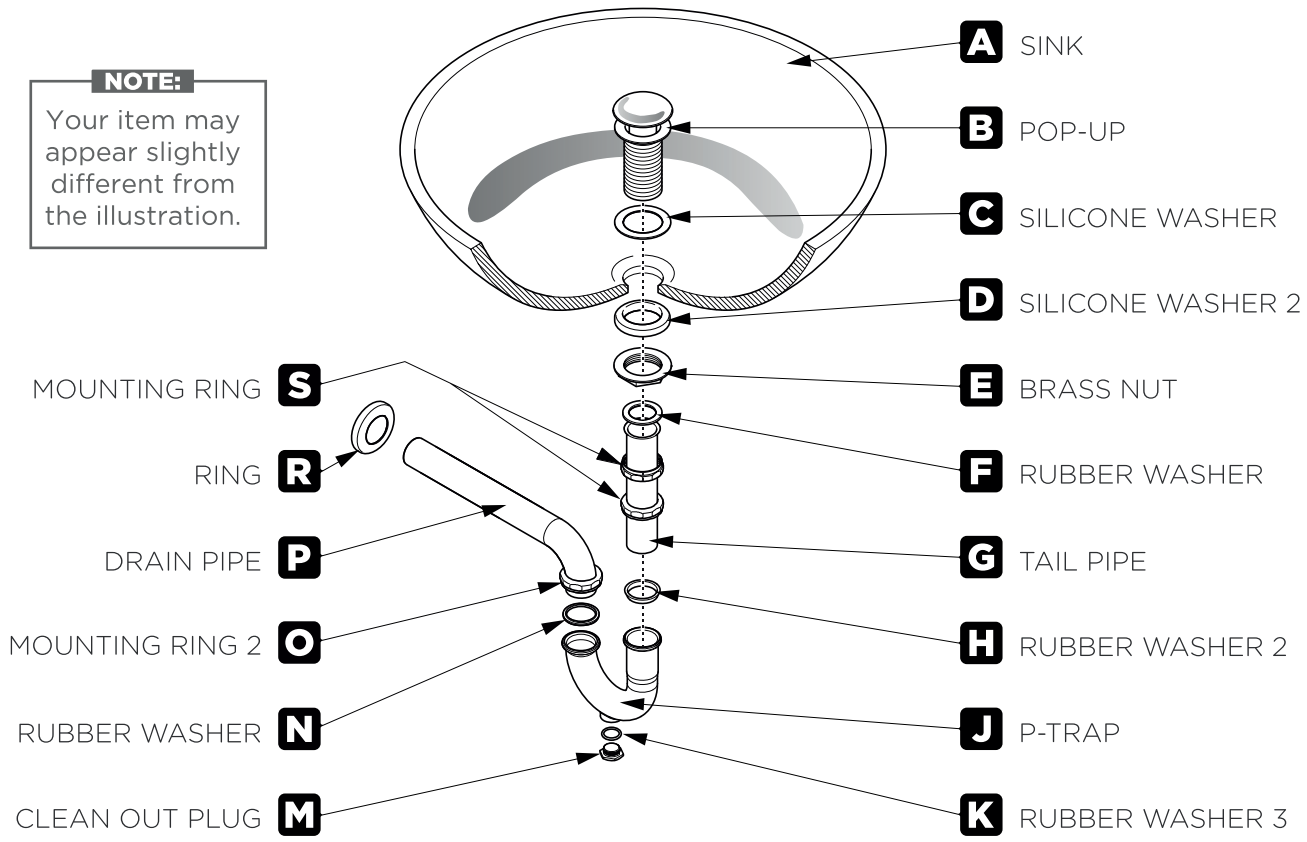

POP-UP INSTALLATION INSTRUCTIONS

FOR SINKS WITHOUT OVERFLOW

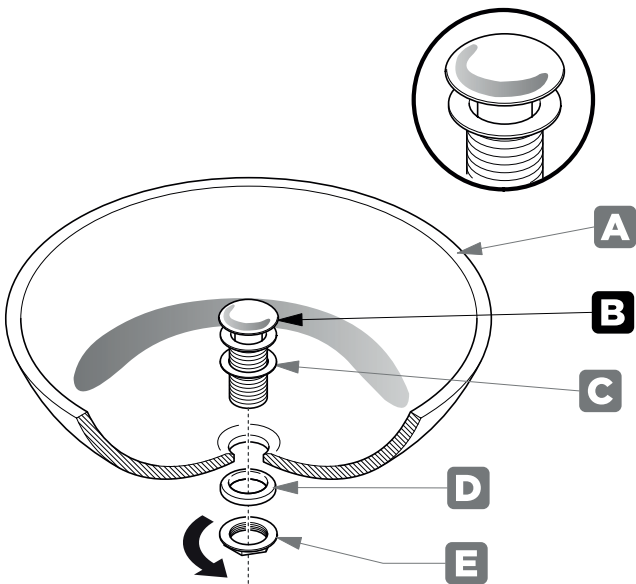

OR

FOR SINKS WITH OVERFLOW

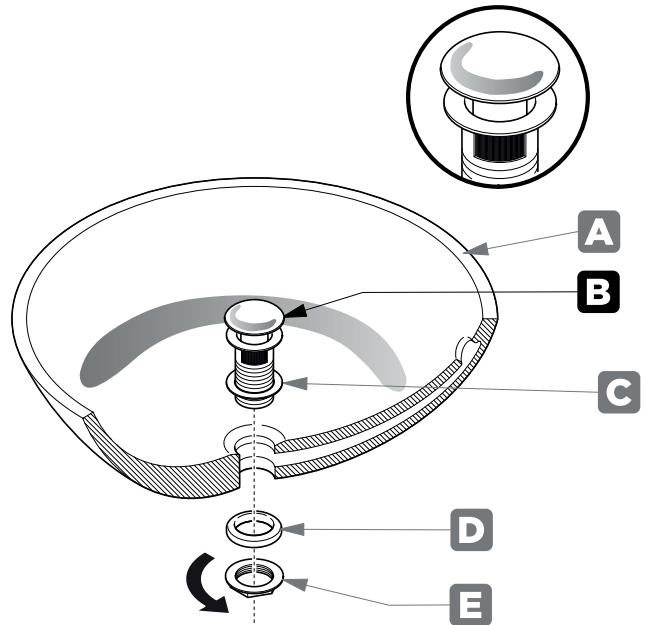

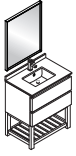

P-TRAP INSTALLATION

1 Install tail pipe (G)

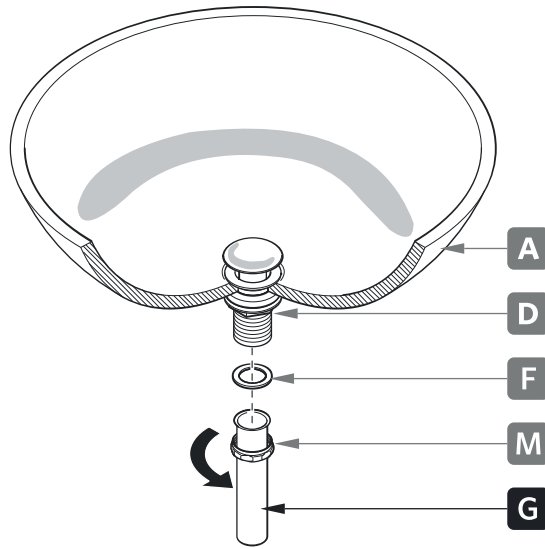

2 Install p-trap (J)

