

A

| Parts Included | QTY |
|----------------------|-----|
| A - Vessel Sink | 1 |
| B - Cut-out template | 1 |

Not Drawn to Scale

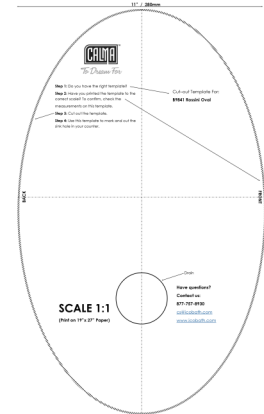

B

1 Installation Steps

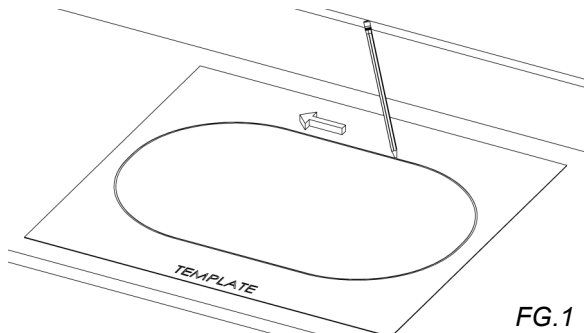

FG.1

1. Using the template provided, mark the shape to be cut out on the counter. FG.1

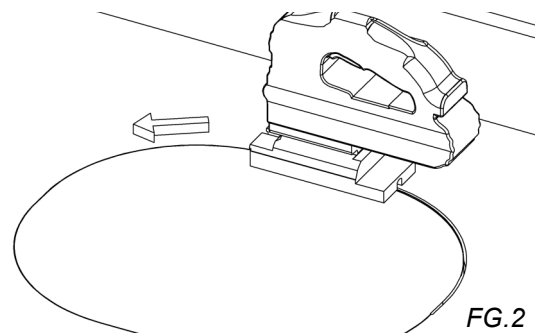

FG.2

2. Cut out the counter -The cutting tools required will depend on the surface to be cut. FG.2

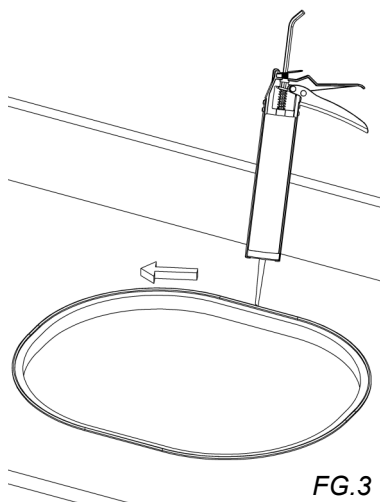

FG.3

3. Apply a bead of silicone to the perimeter of the hole at the point at which the sink sits on the counter. FG.3

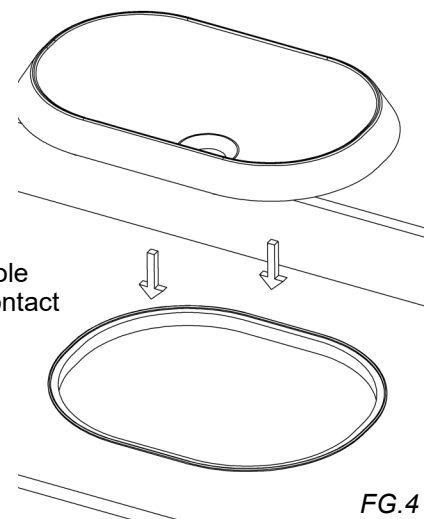

FG.4

4. Lower the sink into the hole and ensure that it makes contact with the silicone. FG.4



To Dream For

Specifications & Drawings

| Model # | Description | Finish | Weight (lb) | Height from Countertop | WxD (mm) | WxD (Inches) |
|---------|--------------------------|-------------|-------------|------------------------|-----------|-----------------|
| B9841 | Rossini Oval Vessel Sink | Gloss White | 12 | 1 5/8" | 500 x 320 | 19.75" x 12.63" |

Warranty: 5 Years

Care & Maintenance: Simple inexpensive household ingredients such as vim cleaner, vinegar, or water with lemon can be used to clean your cast marble basin. Surfaces may be cleaned with standard nonabrasive cleaning agents.

Material specifications: A natural composite of cast marble containing 70% natural aggregate dolomite rock, polyester resins and gel coat.

Overflow: Not Included

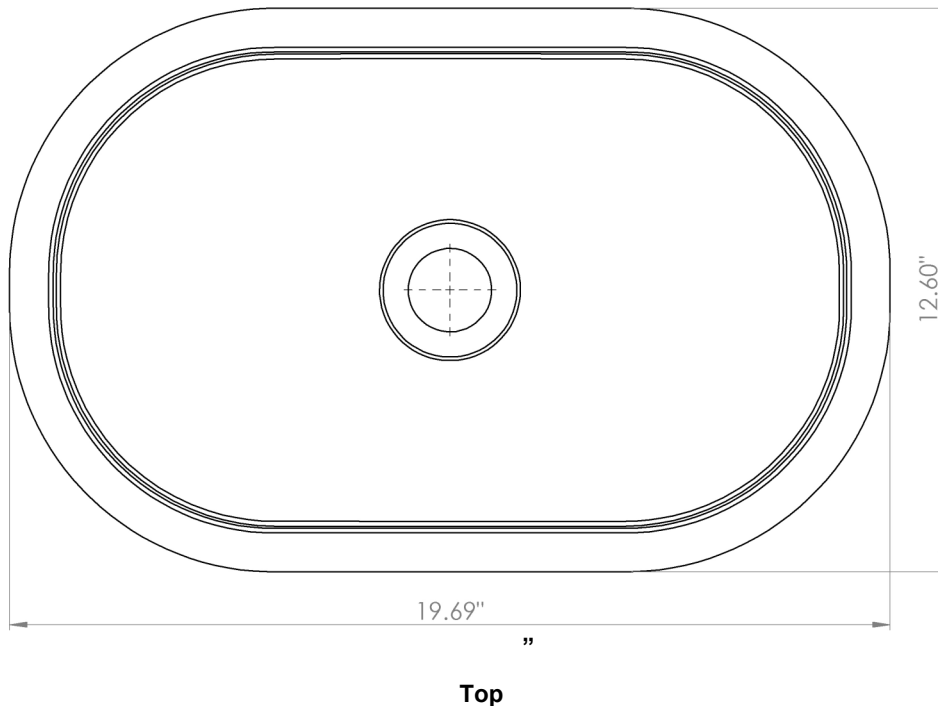
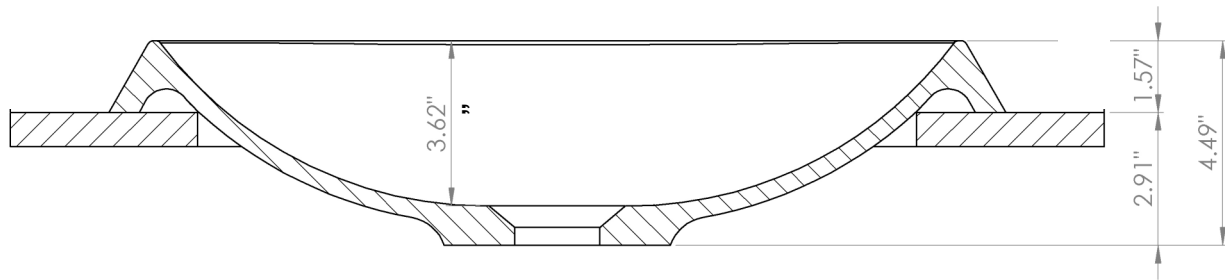

Checkpoint 1:

When positioning the sink in the counter, ensure there is room for the faucet and escutcheon between the sink & the face of the backsplash.

Checkpoint 2:

If you need to cleanup silicone from the edge of the sink, do not use acetone, paint thinner or similar products. Putting blue tape on the counter & around the sink whilst embedding the sink into the silicone helps to keep silicone off the sink.

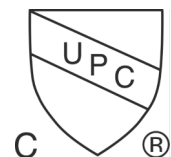

All Dimensions are in Inches