

Scheda Tecnica / Technical Sheet

Le immagini ed i testi sono di proprietà di ZUCCHETTI Rubinetteria S.p.A. - Sono severamente vietata la riproduzione e la vendita - Texts and pictures are property of ZUCCHETTI Rubinetteria S.p.A. - Reproduction and sale are strictly forbidden
 Le caratteristiche dei prodotti possono variare in ogni momento e senza preavviso a discrezione di ZUCCHETTI Rubinetteria S.p.A. - Product specifications can be changed at any time and without warning by ZUCCHETTI Rubinetteria S.p.A.

ZUCCHETTI.
 www.zucchettidesign.it

Rev 0, 31-3-2011

Z46353.8008

codice / code

Delfi

collezione / collection

Batteria a tre fori con bocca girevole e scarico
 3 hole basin mixer stove spout with pop-up waste

descrizione / description



immagine / picture

min
 33.5mm -

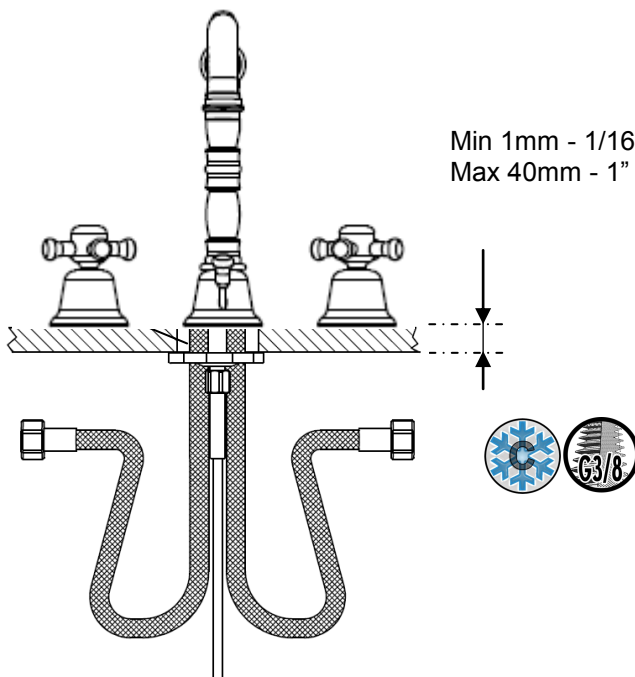

Min 1mm - 1/16
 Max 40mm - 1"

vista frontale / front view

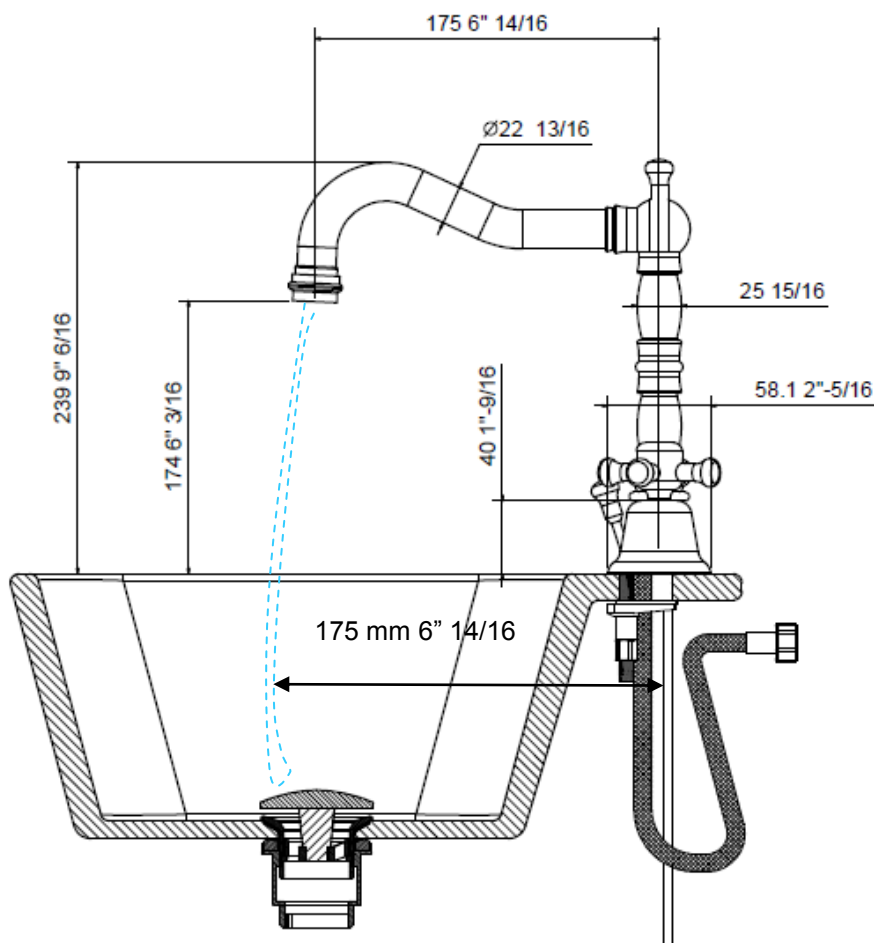

vista laterale / side view



Acqua fredda
 Cold water



Acqua calda
 Hot water



Filettatura
 Thread



Utenze varie
 Outlets



Utenze varie
 Outlets

legenda / explanation

1.

Scheda Tecnica / Technical Sheet

Le immagini ed i testi sono di proprietà di ZUCCHETTI Rubinetteria S.p.A. - Sono severamente vietate la riproduzione e la vendita - Texts and pictures are property of ZUCCHETTI Rubinetteria S.p.A. - Reproduction and sale are strictly forbidden
Le caratteristiche dei prodotti possono variare in ogni momento e senza preavviso a discrezione di ZUCCHETTI Rubinetteria S.p.A. - Product specifications can be changed at any time and without warning by ZUCCHETTI Rubinetteria S.p.A.

ZUCCHETTI.
www.zucchettidesign.it



Pressione Pressure	0,5 bar 7.2 psi	0,7 bar 10.1 psi	1bar 14.5 psi	2 bar 29 psi	2.5 bar 36.2 psi	3 bar 43.5 psi	4 bar 58 psi	5 bar 72.5 psi
Acqua singola Single water	0 lt/min 0 gpm	0 lt/min 0 gpm	0 lt/min 0 gpm	0 lt/min 0 gpm	0 lt/min 0 gpm	0 lt/min 0 gpm	0 lt/min 0 gpm	0 lt/min 0 gpm
Acqua miscelata Mixed water	0 lt/min 0 gpm	0 lt/min 0 gpm	0 lt/min 0 gpm	0 lt/min 0 gpm	0 lt/min 0 gpm	0 lt/min 0 gpm	0 lt/min 0 gpm	0 lt/min 0 gpm
Uscita secondaria Secondary outlet	—	—	—	—	—	—	—	—

portate / flowrates

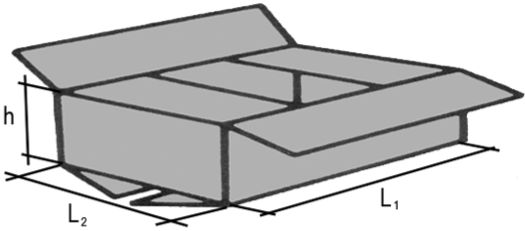























Packaging parti esterne External part packaging		
L ₁ (mm) L ₁ (in)	330 mm 12" 15/16	
L ₂ (mm) L ₂ (in)	250 mm 9" 13/16	
h (mm) h (in)	90 mm 3" 8/16	
Peso (kg) Weight (lb)	4 kg 8.8 lb	



confezione / packaging

	Z9506P	Sifone a s da 1" 1/4 senza piletta 1" 1/4 s trap without waste			
	Z9123P.9500	Rubinetto sottolavabo Da 1/2 con filtro Angle stop valve 1/2" inlet with filter			

articoli correlati / related items

<input type="checkbox"/>		Cartuccia con limitatore di portata Cartridge with temperature-limiter	<input type="checkbox"/>		Vitone a compressione Rubber-seal headwork
<input type="checkbox"/>		Cartuccia con limitatore di temperatura Cartridge with temperature-limiter	<input type="checkbox"/>		Flessibile Hose
<input checked="" type="checkbox"/>		Scarico Pop-up waste	<input type="checkbox"/>		Filtri Filters
<input type="checkbox"/>		Valvola antiritorno Check valve	<input type="checkbox"/>		Chiave per aeratore/rompigetto Aerator/antisplash key
<input type="checkbox"/>		Deviatore automatico Automatic diverter	<input checked="" type="checkbox"/>		Flessibili in acciaio di collegamento all'impianto Stainless-steel flexible connecting pipes to the plumbing system
<input type="checkbox"/>		Deviatore manuale a due vie Manual diverter	<input type="checkbox"/>		Getto controllato Anti-splash
<input type="checkbox"/>		Deviatore manuale a tre vie 3-ways manual diverter	<input checked="" type="checkbox"/>		Aeratore Aerator
<input type="checkbox"/>		Deviatore manuale a cinque vie 5-ways manual diverter	<input type="checkbox"/>		Getto laminare Laminar flow
<input type="checkbox"/>		Cartuccia termostatica Thermostatic cartridge	<input type="checkbox"/>		Getto "spray" Spray jet
<input type="checkbox"/>		Chiave per installazione e manutenzione installation & service tool	<input type="checkbox"/>		Getto a pioggia Rain jet
<input type="checkbox"/>		Vitone a dischi ceramici con rotazione 90° Ceramic disks headwork 90°	<input checked="" type="checkbox"/>		Bocca girevole Swivel spout
<input checked="" type="checkbox"/>		Vitone a dischi ceramici con rotazione 180° Ceramic disks headwork 180°	<input type="checkbox"/>		Limitatore di portata Flow regulator

dotazione / equipment