

Marchio / Brand ZUCCHETTI

Classe / Class ACCESSORI

JINGLE

ZAD150







Appendiabiti. / Hook.



Appendiabiti.

Hook.

Finiture / Finishes

	 C3	 C8	 C40	 C41	 C50	 C51
Cromo / Chrome	Nickel Spazzolato / Brushed Nickel	Nickel Lucido / Polished Nickel	Gold / Gold	Brushed Gold / Brushed Gold	Metal Black / Metal Black	Brushed Metal Black / Brushed Metal Black

JINGLE

ZAD150

Disegno Complessivo / Overall Drawing

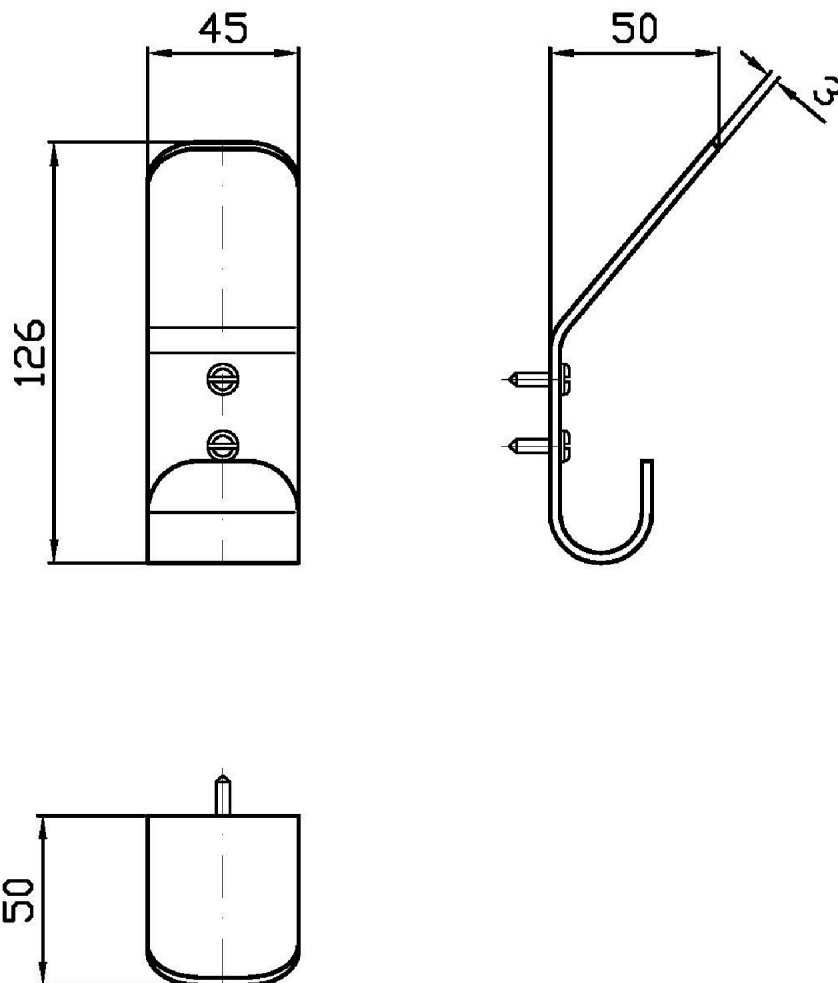

Marchio / Brand ZUCCHETTI

Classe / Class ACCESSORI

JINGLE

ZAD150 Pesì e Misure / Weights and Sizes

Peso (Kg) Weight (lb)	0,29 (Kg)	0,639334 (lb)
Volume (dc3) - (in3)	1,21 (dc3)	0,000074 (in3)
h (mm) - (in)	73 (mm)	2,8740173 (in)
L1 (mm) - (in)	127 (mm)	5,0000027 (in)
L2 (mm) - (in)	130 (mm)	5,118113 (in)

