



PRODUCT INSTALLATION INSTRUCTIONS

TABLE OF CONTENTS

- A.** General Installation Notes
- B.** Drop-In and Raised Profile Sink Installation
- C.** Undermount Sink Installation
- D.** Vessel Sink Installation
- E.** Apron Front Sink Installation
- F.** Wall Mount Vanity Installation
- G.** Bathtub Installation

READ THIS FIRST

A. GENERAL INSTALLATION NOTES:

- **All Native Trails products should be installed by a licensed contractor**
- Observe and comply with all building and plumbing codes.
- As our basins are handcrafted and dimensions are approximate, we recommend using the actual basin for the cutout.
- Use 100% Silicone (non-water based) for all installations.
- **Ensure adequate space behind the basin for faucet and backsplash, including the full range of motion for faucet handles and spouts.**
- Make sure a watertight seal exists on all drain connections.
- Do not place basin directly on floor. After unpacking, place basin on protective material such as packing materials.
- Remember to always use non-abrasive cleaners on Native Trails sinks and tubs. Mild soap and water is recommended. Refer to Care and Maintenance Instructions for further information.
- If unsure which instructions pertain to your product call our Customer Service Department at 800.786.0862. You may also view Installation and Care and Maintenance instructions at www.nativetrails.net.
- **CAUTION:** Risk of personal injury. Bath tubs, large sinks, and vanities can be extremely heavy. Obtain sufficient help to carefully lift or move.

B. DROP-IN AND RAISED PROFILE SINK INSTALLATION:

If vanity top is pre-cut go to Step 4.



1. Use actual basin as your template. Place it upside down on countertop and mark countertop by tracing edge of basin. Be sure to allow clearance for faucet and other accessories or fixtures. ***See note below for Palisades**
2. Measure inside edge of lip and mark countertop accordingly, inside of the first tracing made.
3. Cut countertop midway in-between the two lines.
4. Temporarily place basin in cut-out to verify proper fit.
5. Apply silicone around cut-out in countertop, and place basin in cut-out.
6. For Raised Profile Sinks: Use wood screws from underneath the countertop and screw into wood blocks or use silicone on wood blocks to adhere/secure to countertop. Make sure that the screws align with the wood blocks. If the screws are not placed properly, damage to the copper may occur.
7. Use a level to ensure that the basin is sitting level in all directions, front to back and side to side; while pressing down to seal.
8. Carefully remove any excess silicone.
9. Install the drain according to the drain's installation instructions.

****Palisades: Before cutting the countertop, turn basin over and measure from the bottom inner edge of the apron to the front edge of the basin (approx. 2.5") This will provide the measurement for determining where to cut and place the basin so the apron front extends properly over the edge of the countertop.***

C. UNDERMOUNT SINK INSTALLATION:

If vanity top is pre-cut go to Step 4.

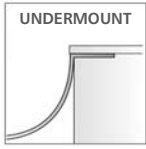

1. Use actual basin as your template. Place it upside down on countertop and mark countertop by tracing edge of basin. Be sure to allow clearance for faucet and other accessories or fixtures.
2. Measure inside edge of lip and mark countertop accordingly, inside of the first line.
3. Cut countertop on inside line.
4. Temporarily place basin in cut-out to verify proper fit.
5. Apply silicone around hole in underside of countertop, and position basin.
6. Use a level to make sure that the basin is sitting level in all directions, front to back and side to side; while pressing down to seal.
7. Copper sinks: Mounting clip fasteners may be used to secure basin under countertop if desired. NativeStone sinks: We recommend the "Sink Undermounter Kit" from Vance Industries, available at www.vanceind.com. These rail systems are available in four sizes: 23" (QN23UM), 25" (QN25UM), 36" (QN36UM) and 50" (QN50UM). Please consult with your installer to determine which system would best fit your needs.
8. Carefully remove any excess silicone.
9. Install the drain according to the drain's installation instructions.

D. VESSEL SINK INSTALLATION:

If vanity top is pre-cut go to Step 3.

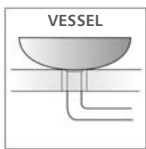

1. Measure outside perimeter of drain opening and mark countertop.
2. Cut countertop for drain opening.
3. Place basin on top of countertop and verify that the drain flange sits down inside of countertop so bottom of vessel is flush with the countertop.
4. Use a level to make sure that the basin is sitting level in all directions, front to back and side to side.
5. Install the drain according to the drain's installation instructions.
6. The hold down nut of the drain pipe will secure the basin to the countertop. Depending on the size of the hole in the countertop, a large washer may also be necessary.
7. A bead of clear silicone can be used to seal the vessel to the countertop, if desired.

E. APRON FRONT SINK INSTALLATION:

1. Make a template and cutout. For built-up mount, cut countertop along the outside line of basin profile. After centering the basin and allowing for faucets, handles and backsplashes, use a pencil to outline the basin as your guide for the cut-out, allowing for any reveal (if desired) before the actual cutting. Depending on the installation type, make proper cut-out in the countertop.
 2. Create a custom support using 2x4's that will adequately hold the weight of the sink from underneath. We highly recommend using a professional installer to install your Native Trails sink.
 3. Place the sink on top of cabinet or into the cabinet front cut-out.
Apply silicone as a gasket between sink and cabinet.
 4. Apply a bead of silicone around top edge of sink. Place countertop on the sink. Make sure that it is centered properly. Remove any excess silicone from the lip or any surfaces.
 5. Install the drain according to the drain's installation instructions. When cleaning up after installation do not use abrasive cleaners, as they may scratch and alter the sink surface and finish. Use warm water, a soft cloth and a non-abrasive soap (such as dish soap) to clean the surface. Refer to Care and Maintenance Instructions for further information.
-

F. WALL MOUNT VANITY INSTALLATION:

(Bordeaux, Halcyon, Harmony, etc.)

1. Check the specified height or determine desired height and determine where studs are located in the wall. Wall mounting hardware can be found at any major hardware store. (If no studs can be found, use heavy duty wall mounting hardware to secure vanity to the wall.)
2. Drill holes for lag bolts that line up with wall studs and height of vanity in the wooden French cleat provided. Make sure slanted edge will fit correctly into the vanity.
3. Drill pilot holes in walls and through studs so that studs will not crack when lag bolt is tightened.
4. Screw lag bolts through wooden French cleat and into the wall making sure it is level and at the right height to support the vanity.
5. Hang vanity on the French cleat attached to the wall.
6. Install top, sink, and drain according to installation instructions.
7. For Harmony: Ensure drawers are flush and level, and that gaps are even between drawer and vanity frame. To level drawers, adjust washer around front screws on either side of drawer slides. Adjustments may be needed on both sides.

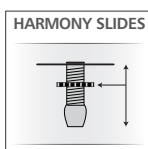

G. BATHTUB INSTALLATION:

Before Installation:

- Unpack and inspect the tub for damage. Place on throw rug or other protective floor covering to prevent damage to the bath or floor.
- Make sure the flooring offers adequate support for the tub, and verify that the sub floor is flat and level.
- Ensure proper access to the final plumbing connections.
- For tub protection, position a clean drop cloth or similar material in the bottom of the tub. Be careful not to scratch the surface of the tub.

BATHTUB INSTALLATION (CONT.):

Installation:

1. Place the tub onto an adequately supported level floor.
2. Install the drain to the bath according to the drain manufacturer's instructions.
DO NOT connect the trap at this time.
3. With help, carefully move the tub into place.
4. Provide access to all plumbing connections to simplify future maintenance.
5. Insert the drain tailpiece into the trap.
6. Connect the trap to the drain according to the drain's installation instructions.
7. Install the faucet valving according to the faucet manufacturer's instructions.
8. Open the hot and cold water supplies and check all connections for leaks.
9. Fill the tub to the overflow and check for leaks.

BATHTUB INSTALLATION (CONT.):

After Installation:

- When cleaning up after installations, **DO NOT USE ABRASIVE CLEANERS**, as they may scratch and change the tub surface.
 - Use warm water, a soft cloth and a non-abrasive soap (such as dish soap) to clean the surface.
 - Refer to the Care and Maintenance instructions for further information.
-



800.786.0862

Please visit nativetrails.net for more information
and to download product specifications

Tools Needed:

Phillips Screw Driver

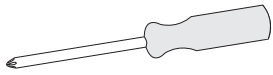

Level

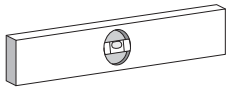

Materials Included:

(2) Mounting Brackets

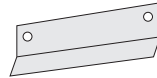

(2) Mirror Screws

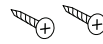

(2) Wall Screws

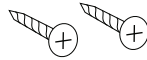

(2) Drywall Anchors

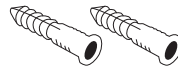

1.

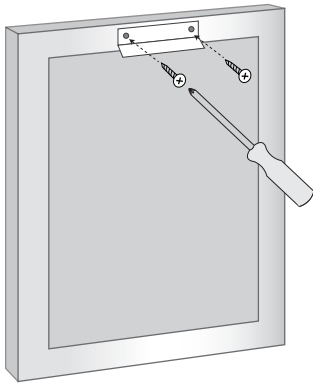

Attach mounting bracket to back of mirror frame. For best results use level and drill pilot holes.

2.

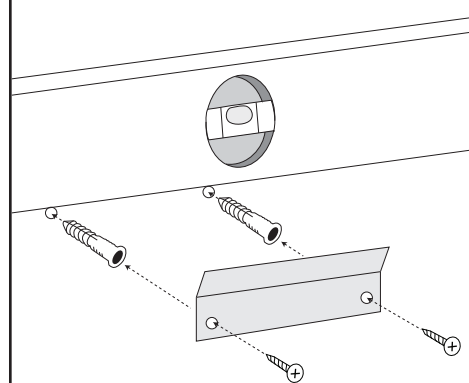

Attach mounting bracket to the wall using drywall anchors, wall screws, and level.

3.

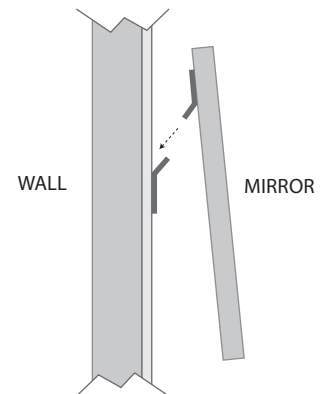

Hang mirror on mounting bracket on wall. Double check with level.

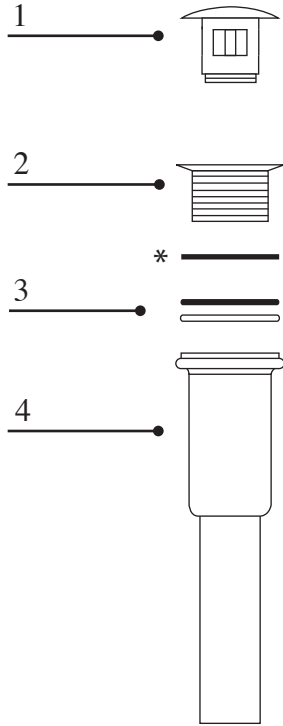

1. Assemble seals (3) into the underbody (4)
2. Apply a small bead of 100% Silicone (non-water based) to the underside of the waste (2)
3. Locate the underbody (4) and seals (3) central to the underside of the vessel sink hole
4. Locate the waste (2) central to the top side of the vessel sink hole
5. Assemble decorative cover (1) as per diagram, hand tighten + ¼ turn.

* Note: Rubber washer is only used for glass sinks.

Remove all excess silicone around the drain after the drain has been installed

WWW.NATIVETRAILS.NET

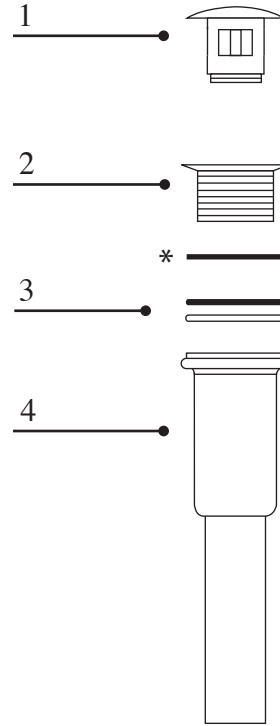

1. Assemble seals (3) into the underbody (4)
2. Apply a small bead of 100% Silicone (non-water based) to the underside of the waste (2)
3. Locate the underbody (4) and seals (3) central to the underside of the vessel sink hole
4. Locate the waste (2) central to the top side of the vessel sink hole
5. Assemble decorative cover (1) as per diagram, hand tighten + ¼ turn.

* Note: Rubber washer is only used for glass sinks.

Remove all excess silicone around the drain after the drain has been installed

WWW.NATIVETRAILS.NET

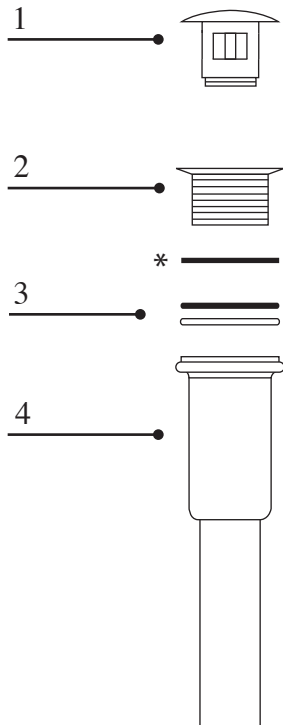

1. Assemble seals (3) into the underbody (4)
2. Apply a small bead of 100% Silicone (non-water based) to the underside of the waste (2)
3. Locate the underbody (4) and seals (3) central to the underside of the vessel sink hole
4. Locate the waste (2) central to the top side of the vessel sink hole
5. Assemble decorative cover (1) as per diagram, hand tighten + ¼ turn.

* Note: Rubber washer is only used for glass sinks.

Remove all excess silicone around the drain after the drain has been installed

WWW.NATIVETRAILS.NET

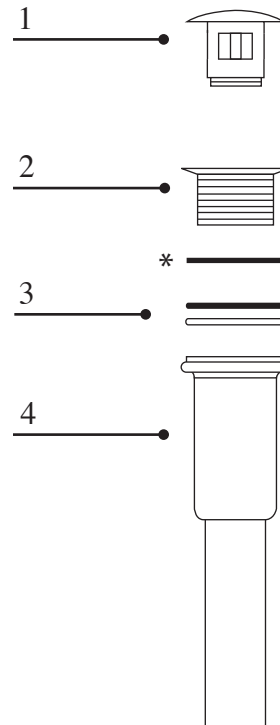

1. Assemble seals (3) into the underbody (4)
2. Apply a small bead of 100% Silicone (non-water based) to the underside of the waste (2)
3. Locate the underbody (4) and seals (3) central to the underside of the vessel sink hole
4. Locate the waste (2) central to the top side of the vessel sink hole
5. Assemble decorative cover (1) as per diagram, hand tighten + ¼ turn.

* Note: Rubber washer is only used for glass sinks.

Remove all excess silicone around the drain after the drain has been installed

WWW.NATIVETRAILS.NET