

66 x 36 x 23 ¾

WHIRLPOOL LEFT DRAIN MODEL #W6636ISL

WHIRLPOOL RIGHT DRAIN MODEL #W6636ISR

AIR-WHIRLPOOL LEFT DRAIN MODEL #W31LUX6636ISL

AIR-WHIRLPOOL RIGHT DRAIN MODEL #W31LUX6636ISR

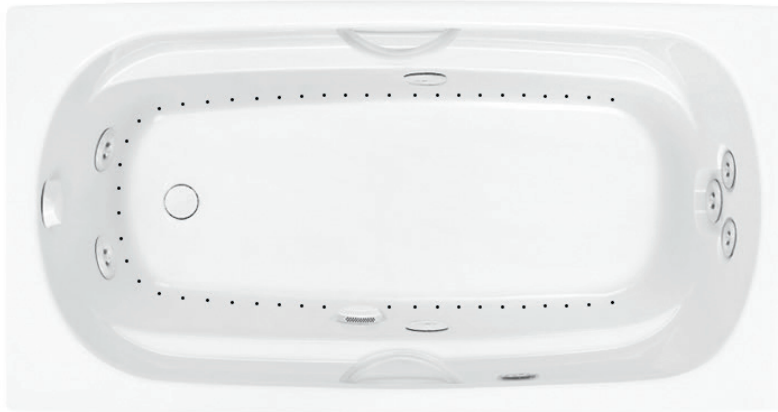

FEATURES ~

- Integral skirt with removable access panels
- Integral tile flange
- Deep, ergonomic bathing well
- Sculpted armrests
- Bolt-on grab bars (chrome or color matched)
- Slip resistant floor
- Premium cast acrylic surface
- Limited lifetime warranty

AVAILABLE SYSTEMS

WHIRLPOOL

- Electronic control
- 7 hydrotherapy jets
 - 3-jet back, shoulder and neck massage system (dual port, spinning)
 - Leg and foot jets
- Whirlpool pump

AIR-WHIRLPOOL COMBINATION

- Whirlpool system, plus:
- Perimeter air system
- Variable speed heated-air blower with purge and dry cycle
- Electronic wave and pulse modes
- 1.5kW inline maintenance heater

SANTA CRUZ

66 x 36 x 23 3/4

BASE MODEL	PKG. WT. LBS.	JETS	DRAIN	MODEL #	MSLP
<input type="checkbox"/> Whirlpool	153	7	Left	W66361SL	\$4,635
<input type="checkbox"/> Whirlpool	153	7	Right	W66361SR	\$4,635
<input type="checkbox"/> Air-Whirlpool	292	7	Left	W31LUX66361SL	\$6,197
<input type="checkbox"/> Air-Whirlpool	292	7	Right	W31LUX66361SR	\$6,197

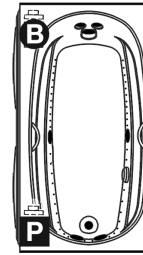

ESTATE

PRODUCT FEATURES

- Bolt-on grab bars (2): color matched (Biscuit or White), Chrome
- Sculpted armrests
- Integral tile flange
- Integral skirt with removable front access panels
- Skirted models only available in White and Biscuit

ILLUSTRATION KEY

AIR-WHIRLPOOL MODELS

- P** = Pump Location
- B** = Blower Location

WHIRLPOOL ONLY MODELS

- = Pump Location

TILE FLANGE CONFIGURATIONS

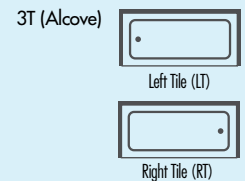

OPTIONS (x = insert desired option code)	ENTER DESIRED OPTION CODE	MSLP
Cast acrylic stock color (COLxx): Biscuit (BI) White (WH)	_____	No charge
Cast acrylic color upgrade (COLxx): Biscuit (BI)	_____	\$35
Metallic trim finish: Chrome (MTCH)	_____	\$315
Metallic trim finish (MTxx): Polished Brass (BR) Brushed Nickel (SN)	_____	\$390
Bolt-on grab bars (2) (BOGBxxx): Chrome (SS2) White (WH2) Biscuit (BI2)	_____	No charge
Bolt-on grab bars (2) (BOGBxxx): Polished Brass (BR2) Brushed Nickel (SN2) Oil Rubbed Bronze (OB2)	_____	\$250
Magnetic pillow (MPxxxxx): White (WHPIL) Black (BKPIL)	_____	\$105
Cable drive waste & overflow: Chrome (CDCHCD)	_____	\$345
Cable drive waste & overflow, color-matched (CDxxxx): Biscuit (BICD) White (WHCD)	_____	\$390
Cable drive waste & overflow (CDxxxx): Oil Rubbed Bronze (OBCD) Polished Brass (BRCD) Brushed Nickel (SNCD)	_____	\$440
Chromatherapy, installed (CLM1)	_____	\$335
Inline heater - 1.5kW, factory installed (whirlpool only) (HTH1)	_____	\$400
Wood shipping crate (PKCR)	_____	\$460
Rush order program* (DELRD)	_____	\$325
Residential delivery* (DELRD)	_____	\$205
Residential delivery with lift gate* (DELLG)	_____	\$454

*For program terms and conditions, see page iii.

BASE PRICE (insert MSLP of base model selected in upper table)	+ \$ _____
OPTIONS SUB TOTAL	\$ _____
ORDER TOTAL	= \$ _____

ORDERING KEY

In the part number, "xx" means an option code must be inserted.

Cast Acrylic stock color (COLxx) ← part number

option code → White (WH)

Example: COLxx + WH = COLWH
Cast Acrylic stock color in White

Manufacturer reserves the right to discontinue models, colors, options and trim finishes without notice.

Customer Name: _____ Date: _____

Additional Information:

SANTA CRUZ

66 x 36 x 23 3/4 inches

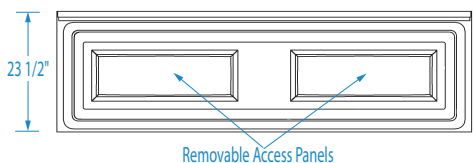
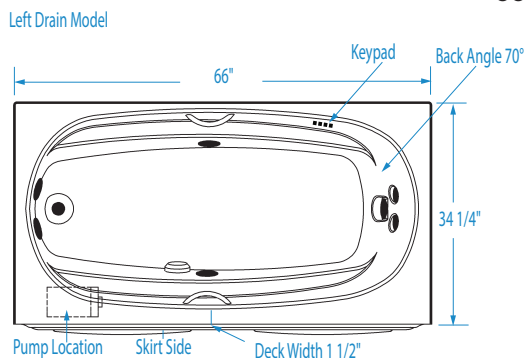
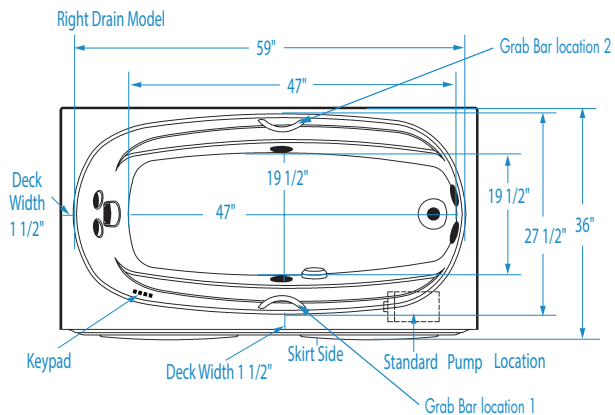

Note: Requires a mortar base. ABS Support Base not included.

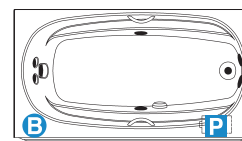
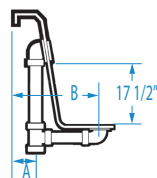

Note: For Air-whirlpool, no alternate pump/blower location available.

Note: Grab Bar option comes with two grab bars.

FEATURES lbs (kg) Dimensional Tolerance ± 3/8". Dimensions needed for site preparation should be measured from the unit. Aquatic assumes no responsibility for preparatory work.

Type and Model #	Material	Jets	Pump	Air System	Blower	Heater	Controls	Drain	Pkg. Wt.
Whirlpool #W66361SL/R	Cast Acrylic	7	102 GPM	—	—	1.5 kw Inline (optional)	Electronic	LH or RH	153
Air-Whirlpool #W31LUX66361SL/R	Cast Acrylic	7	102 GPM	Channel	Variable speed	1.5 kw Inline	Electronic	LH or RH	292

DIMENSIONS inches

Width Overall / Net	Depth Overall / Net	Height Overall / Net	Skirt Height
66	36	23 3/4	22 5/8

SUMP DATA inches

Capacity to Overflow gal (ltr)	Min. Operating Capacity gal (ltr)	WIDTH @ centerline		DEPTH @ centerline	
		Top	Bottom	Top	Bottom
85	66	59	47	27 1/2	19 1/2

PLUMBING DIMENSIONS inches

A	B	Drain Diameter / Clearance
1 3/4	10 3/4	

ELECTRICAL DATA

Component	Specification	Requirement
Pump	9 AMP; 120V	15 AMP; 120V, separate circuit; Class A GFCI
Optional Heater	1.5 kW; 12 AMP; 120V	15 AMP; 120V, separate circuit; Class A GFCI
Blower	1.0 HP; 9.5 AMP; 120V	15 AMP; 120V, separate circuit; Class A GFCI

NOTE:
1) This whirlpool must be hard wired to the breaker box. Three outlets will be supplied on the air-whirlpool.

- NOTES:
1) Where applicable, utilize cut-out templates packed with unit for deck cutouts.
2) 16 x 16 minimum access required at pump/blower location(s).
3) If a (3T) tiling flange is selected, then the keypad is located opposite of the flange.