

Model : E010254

Designed By: **PHOENIX DESIGN | GERMANY**

- Features :**
- 3 full-extension, soft-close drawers with Hettich brand hardware
 - 2 UL approved electrical outlets and 2 USB ports in top drawer (require hardwiring)
 - 47" length of wire
 - Woven fiber drawer liners
 - Dovetail drawer construction and drawer finger pulls
 - Fully finished interiors
 - Solid wood construction (no MDF)
 - Multi-step polyurethane finish resists moisture and scratches
 - Leg levelers included
 - U.S. PATENT PENDING

All Ronbow cabinets are made of solid hardwood or hardwood plywood and meet strict CARB II Standards. No particle board or Micro-Density Fiberboard (MDF) are used.

Available Finish : Traffic Gray (E11) with Light Oak (E48) drawer interiors, legs and top
Stone Gray (E73) with American Walnut (E56) drawer interiors, legs and top

Top

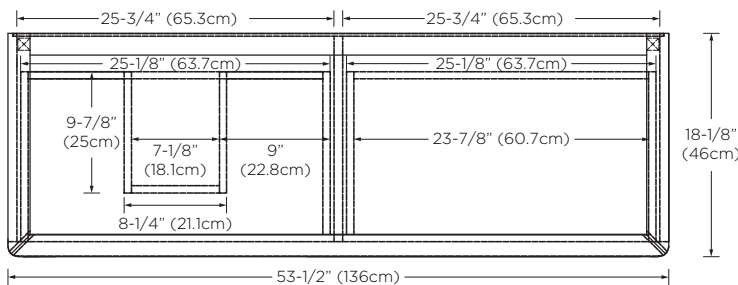

Front

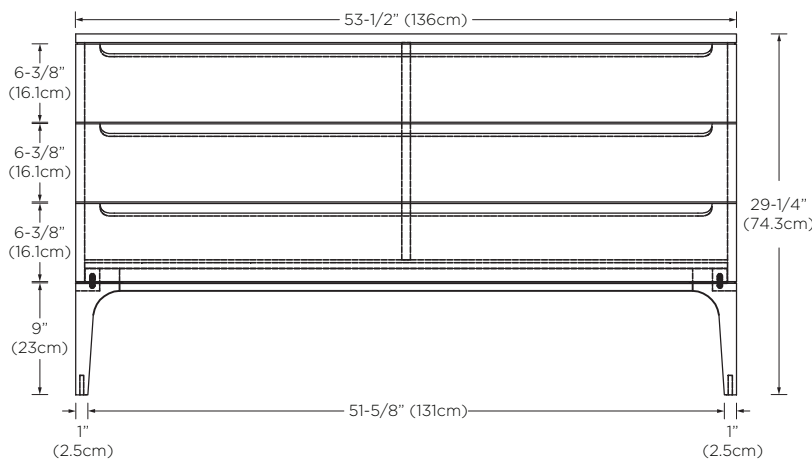

Side

