

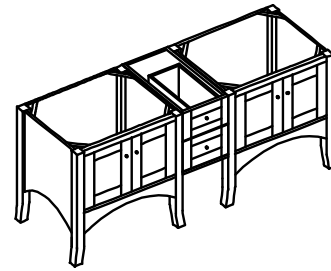

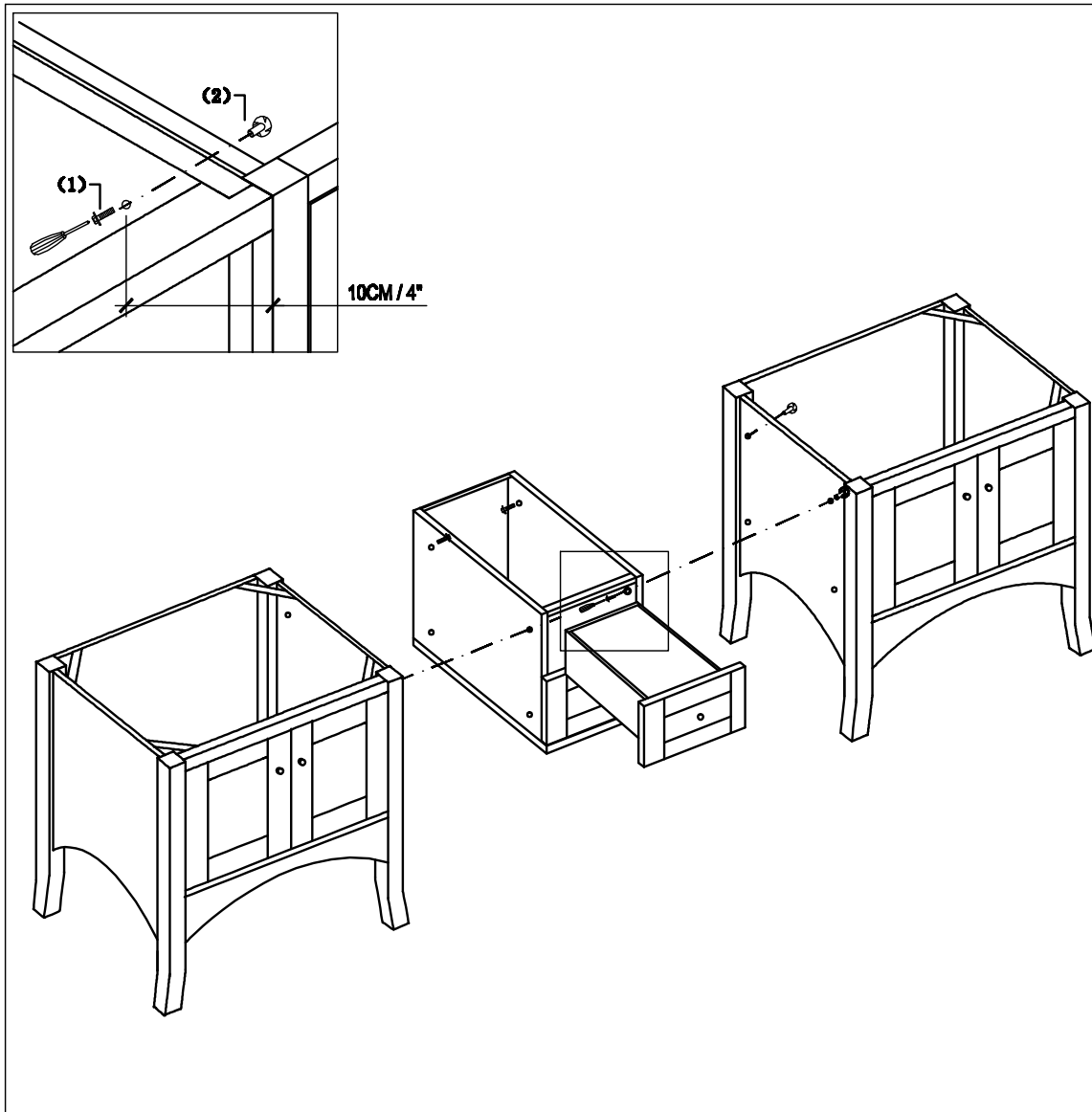





FAIRMONT
designs.



12" DRAWER BRIDGE



PARTS INCLUDED			TOOLS AND MATERIALS			
(1)	 5/16" × 1-1/2"L	8PCS				
(2)	 5/16" × 3/8"L	8PCS				

Fairmont Designs highly recommends that you seek a professional installation specialist if you are unsure of installation. Please note: Fairmont Designs is not responsible for any installation error, damages or injuries, actual or consequential, resulting from possible printing error in instruction