

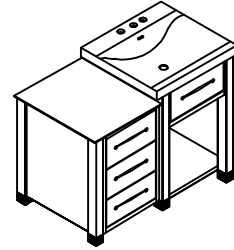

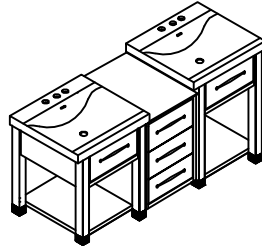

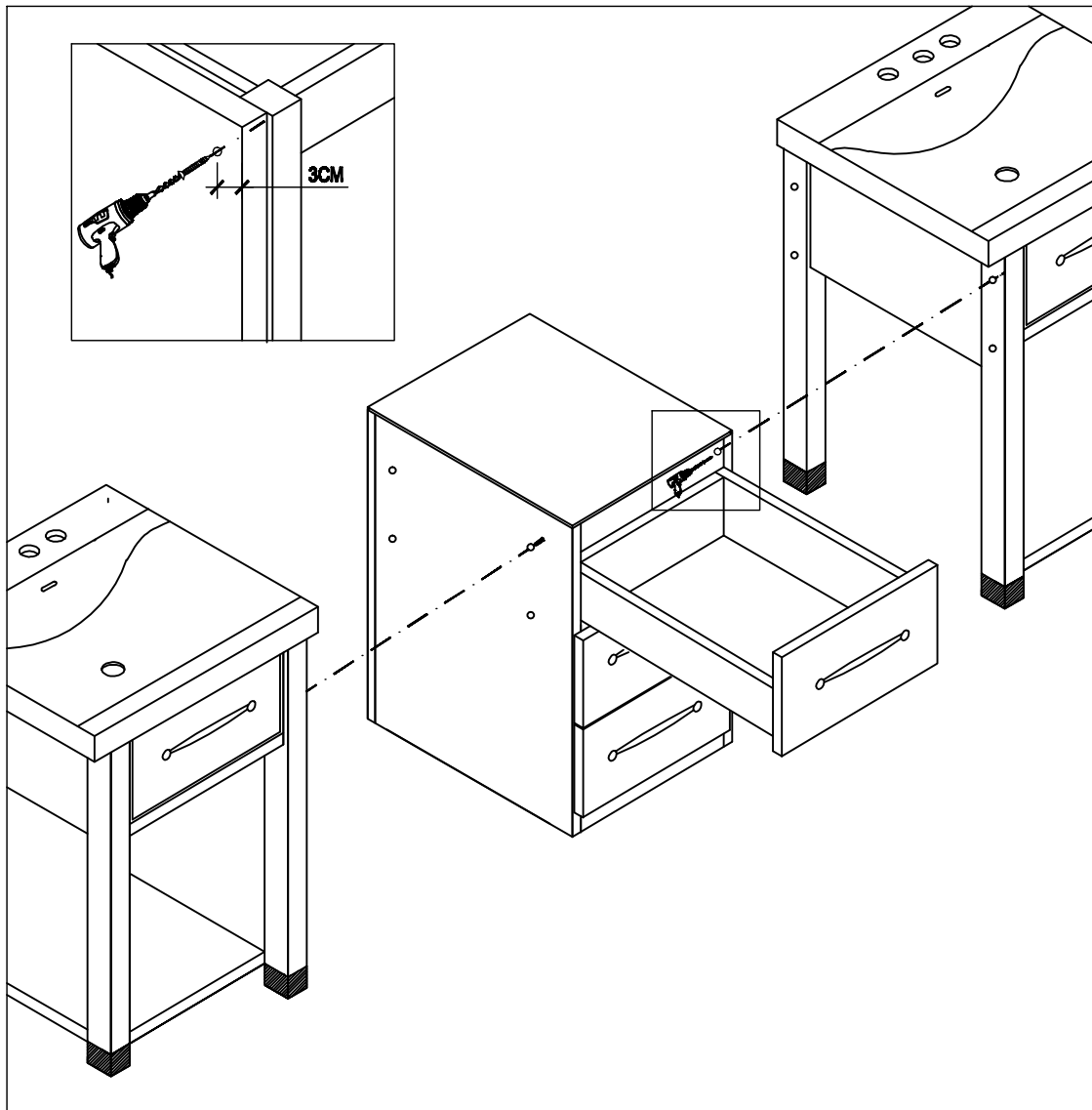



**FAIRMONT**  
designs.



## 18" DRAWER BRIDGE



PARTS INCLUDED			TOOLS AND MATERIALS NEEDED			
A	 5/16" x 1-1/4" L	10PCS				
			Electric drill	Screwdriver	Tape measure	Pencil

Fairmont Designs highly recommends that you seek a professional installation specialist if you are unsure of installation. Please note: Fairmont Designs is not responsible for any installation error, damages or injuries, actual or consequential, resulting from possible printing error in instruction