

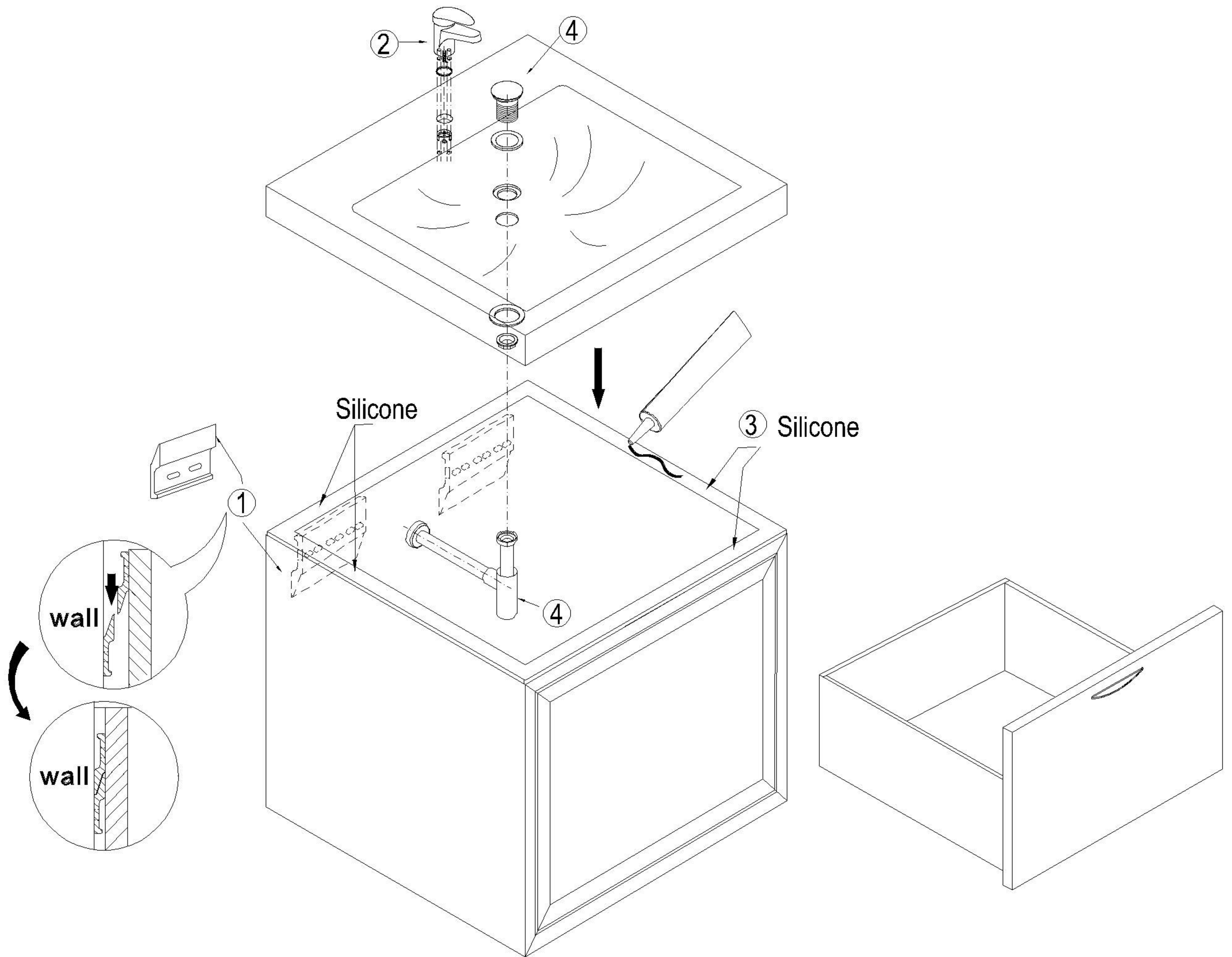





21" WALL HUNG VANITY&SINK

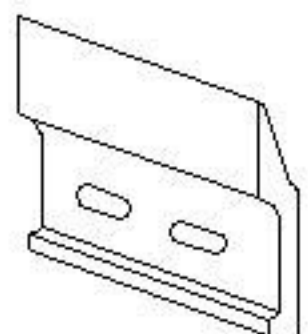
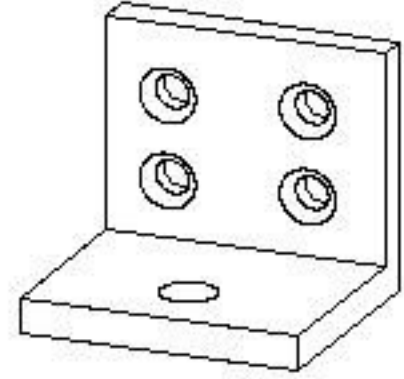
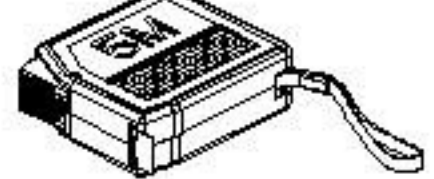
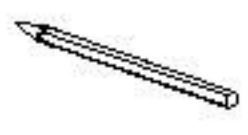
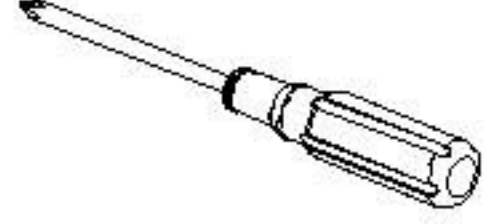

attached hardwares				Tools required for installation		
						
A*8	B*6	D*2	E*2	Electric drill	drill bit	Tape measure (3M~5M)
						
				Silicone	Pencil	Screwdriver